



2024

hidea™ 2024

DREAM, CREATE, CONNECT



Stay updated



@hideagifts

hideagifts.com

Index

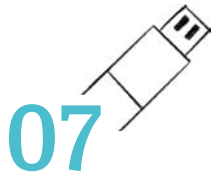

07

Technology

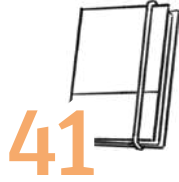

41

Office



61

Write



91

Bags



121

Shopping



141

Sports & Outdoor

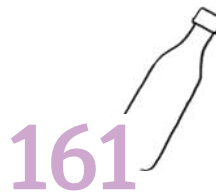

161

Drinkware

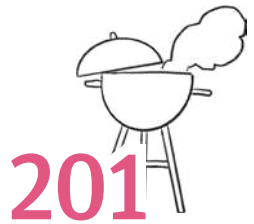

201

Home



229

Personal & Travel

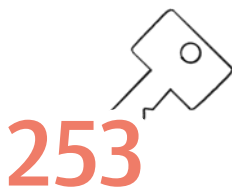

253

Keychains

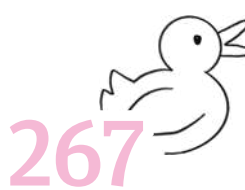

267

Kids



277

Summer



287

Sun & Rain



299

Textile



318

Connect'in



.20



.53 / .75 / .92



.230



.299



DREAM, CREATE, CONNECT

Aware of the challenges imposed by the new realities, we keep holding the dream of building a brighter future. We strengthen our connection to our customers through a collection that aims to be relevant and have a positive impact on society and the world.

Our promise to you: Embracing sustainability for a brighter future.

Sustainability isn't just a concept, it's our commitment to a brighter and more responsible future. We understand the vital significance of preserving our planet, supporting our people, and fostering innovation in our business practices. We believe that these three pillars - Business & Innovation, People, and Planet - are interconnected and essential for a thriving future.

Join us on our journey as we strive to make every action count, every choice eco-conscious, and every day a step closer to a world we can all be proud of.



BUSINESS & INNOVATION

Develop reliable products to drive sustainable growth, powered by efficiency, innovation, and a conscientious supply chain.



PEOPLE

Foster a compassionate, diverse, and stimulating work environment for our employees, maintain strong and transparent relationships with our suppliers, and actively contribute to the development of an inclusive society in our community.



PLANET

Steer and oversee our operations with a strong focus on low carbon footprint and resource efficiency, championing conscientious consumption.

HOW DO WE MAKE OUR PRODUCTS ACCOUNTABLE?

People and Governance



Quality, Environment,
Health and Safety



Product collection focused
on Sustainability



Certified products are identified in the catalogue as FSC™.

Together we can make a difference and the time is now. *Decide tomorrow today.*

Quality customisation services

DTG DIRECT TO GARMENT



Digital printing technique for 100% cotton textile products. The logo is placed directly onto the fabric through a printer.

TRD DIGITAL TRANSFER



The logo is printed directly from a printer onto paper, which is then applied using pressure and heat. Full color printing is possible.

FIR FIRING



The logo is placed on the product through the transfer technique using special inks. The product is then placed in an oven (firing) to be baked at low temperature (personalisation up to 10 colours) or at high temperature (personalisation in black and/or white).

LSR LASER



Use of a high-precision laser beam, allowing for low-relief engraving. This laser can be fibre optic, suitable for metals, or CO2, suitable for wood and cork, or UV, suitable for glass.



LAS CIRCULAR LASER



Use of a high precision laser beam optimised for application on curved surfaces.

SCR SCREEN PRINTING

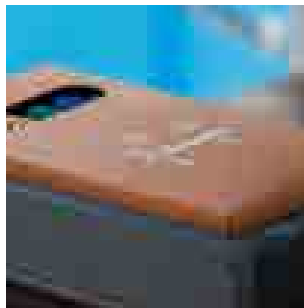

Printing a logo on a photolitho, which is passed onto a wired screen using ultraviolet light. The ink is applied using a squeegee and must be dried.

TRS TRANSFER



Printing the logo onto paper through a screen, which is then applied to the product using pressure and heat. Recommended for non-flat products such as backpacks.

SRC CIRCULAR SCREEN PRINTING

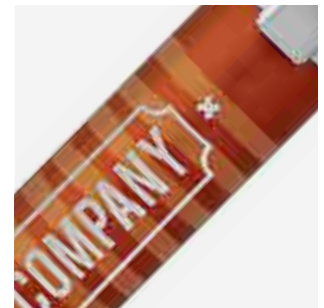

Process identical to screen printing but orientated for printing on circular products, such as ball pens.

SUB SUBLIMATION

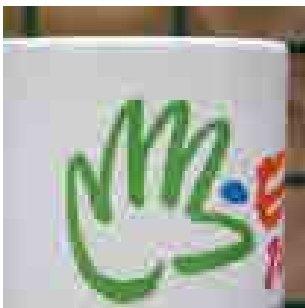

Printing a logo on a paper using a printer with sublimation inks. The ink is transferred to the product by pressure and heat.

STI STICKERS



Printing stickers on white, silver or gold paper with a great variety of sizes and shapes.

EDB EMBROIDERY

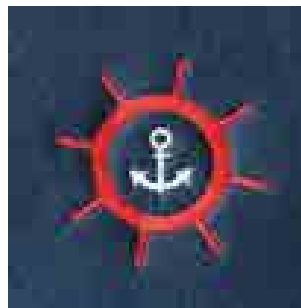

Technique that allows customisation on different types of fabric with great quality and perfection.

ETD 3D EMBROIDERY



A technique that allows you to personalise different types of fabric, achieve a high quality finish and achieve perfection with three-dimensional personalisation in relief.



SND SANDBLASTING



Printing of the logo through sandblast against a surface at high speed.

HTS HOT STAMPING



Reproduction of logos through a hot press on leather products or imitation leather. A metallic colour (gold or silver) can also be applied on the mould.

DOM DOMING



Application of a layer of resin (epoxy) on printed paper. The product must be dried at high temperature to form a protective and resistant layer giving it a 3D effect.

DGL DIGITAL PRINTING



Digital printing consists of printing paper, with photographic quality. This technique is widely used for labels or pins.

HDG HYDROGLAZE



Spraying organic colours on the external surface of white porcelain mugs. After baking, the mug is ready for other printing techniques, such as firing or sandblasting.

TXP TEXTILE SCREEN PRINTING



Process identical to screen printing but orientated for printing on large format textile products.

PDP PAD PRINTING

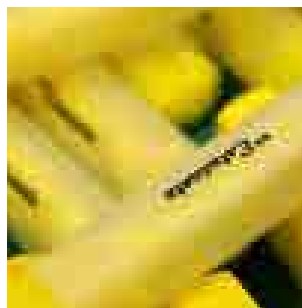

Ideal technique for small objects and curved shapes, as the transfer of ink is made through a silicone pad that adapts to them.

DUV DIGITAL UV



Printing of the logo in a machine similar to a cartridge printer on flat or slightly curved materials. The drying is done through ultraviolet light.

UVC CIRCULAR UV



Digital UV printing applied to cylindrical and conical objects around their entire circumference.

How to read our descriptions

Name Article reference

Product description

Product dimensions

41 x 60 x 23 mm

Available customisation techniques with the recommended one in bold

TRs, EDB, ETD, TRD, TXP

Customisation on request
Without customisation



TECHNOLOGY

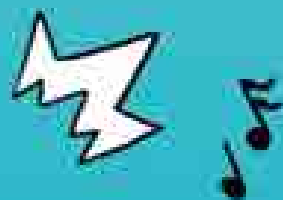

Headset with ANC

Active noise cancellation allows you to work without distraction.



103



Bettencourt 97138

 Foldable wireless headphones in ABS (59% rABS) with Active Noise Cancelling (ANC) function. These headphones feature BT 5.1 transmission and a 400 mAh battery, giving you a battery life of approximately 15 hours. When connected to your mobile device or computer, they can be controlled via convenient controls on the headphones. If necessary, they can also be used via a 3.5 mm jack cable. USB-C cable to charge. Supplied in a box and pouch.

Flap: 300 x 200 mm

 PDP



106

103



Sovery 97096

 ABS (64% rABS) wireless charger with maximum power up to 10W. The charger has 5V/2A, 9V/1.67A inputs. USB cable to charge. Supplied in a kraft paper gift box.

Ø99 x 7,5 mm

 PDP, DUV



106

103



Turing 97097

 ABS (26% rABS) portable speaker with outdoor LED strip, with BT 5.0 transmission. It has a power of 3W (4Ω) and autonomy of up to 4 hours. It also has the function to answer calls and connect to the playlist of the mobile device. Supplied in a kraft paper gift box.

Ø55 x 63 mm

 PDP

Waterproof



Recycled ABS speaker

A conscious choice with the same sound quality.



Sheeran 97140

ABS splash-proof speaker (100% rABS) with a built-in microphone. The battery capacity is 1200 mAh and the sound power is 10W. The speaker has BT 5.0 transmission, TF player, auxiliary input and volume control. It can answer calls, control and connect easily to your mobile device's playlist. The grille can be fully customised. USB-C cable to charge. Supplied in a gift box.

50 x 75 x 170 mm

DUV



The grille can be fully customised.
USB-C cable to charge



Bamboo Collection

The authenticity and durability of bamboo are carefully crafted into different products allowing you to enjoy them in your daily life.



16 white and 9 yellow LEDs

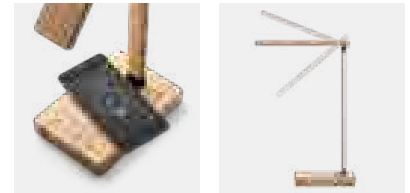

Wireless charger



Morey 97122



Bamboo foldable table lamp with wireless charger, with 16 white and 9 yellow LEDs.



The wireless charger is fast charging, having a power up to 10W, with 5V/2A, 9V/2A inputs and USB-A output with 5V/2A power. Includes a USB-C charging cable. Supplied in kraft box.

432 x 110 x 37 mm

LSR



103



Bromley 97099



ABS and bamboo desk station with the following functions: clock, alarm, humidity monitor and thermometer. Includes two AAA batteries. Supplied in a kraft paper gift box.

130 x 130 x 21 mm

PDP, DUV, LSR



Arber 97125



Bamboo and ABS speaker. It has 5.0 BT transmission to connect to your mobile device. It has battery power of 3W and capacity up to 300 mAh that allows an autonomy up to 2 hours. Supplied in a kraft paper gift box.

Ø74 x 42 mm

LSR, PDP



Glashow 97256



Bamboo speaker with microphone. 3.0 BT transmission and a micro-USB port for charging. Battery with capacity up to 300 mAh, autonomy up to 3 hours and 3W (4Ω) power. Features include call answering, volume control and connectivity to the mobile's playlist. USB cable to charge and audio cable (Jack/Jack 3.5 mm). Supplied in a kraft paper giftbox.

Ø60 x 52 mm

PDP, DUV



160



160



103



Gould 97126

Bamboo and ABS wireless headphones with 5.0 BT transmission, AUX input and TF card reader. It has a battery capacity up to 400 mAh and giving you a battery life of approximately 5 hours. Supplied in a kraft paper gift box.

± 160 x 190 x 45 mm

LSR, PDP



103



Mayer 97098

ABS (25% rABS) and bamboo portable speaker. With 3W power, BT 5.0 transmission and radio function. Autonomy up to 4h with a 500 mAh battery. Supplied in a kraft paper gift box.

± 70 x 70 x 37 mm

DUV, LSR



103

Battery life up to **5h**



Tilly 97095

ABS (36% rABS) and bamboo portable speaker. With 3W power, BT 5.0 transmission and radio function. Autonomy up to 5h with 1200 mAh battery. Supplied in a kraft paper gift box.

± 135 x 40 x 65 mm

DUV, LSR





160



Fitch 97909

Bamboo portable battery with wireless charger. Lithium battery with a capacity of 5,000 mAh and a life span ≥ 500 cycles. Contains 5V/2A input/output, charging indicator, 1 micro USB port, 1 type C USB port and 1 USB port. Maximum wireless output power of 5W. USB-C cable to charge. Compatible with smartphones with wireless charging technology. Supplied in a kraft paper gift box.

140 x 70 x 12 mm

LSR, PDP, SCR



160



Kohn 97915

Bamboo portable battery with lithium battery with a capacity of 5,000mAh and a life span ≥ 500 cycles. 5V/2A input and 5V/1-2A output with 1 micro USB port, 1 type C USB port and 1 USB port. Includes USB charging cable.

120 x 51 x 15 mm

LSR, PDP, SCR



160



Moser 97127

Bamboo hub with 2 USB-A ports and 1 USB-C port. Allows data transfer. Supplied in a kraft paper gift box.

78 x 38 x 11 mm

LSR, PDP, SCR



103



Rubins 97091

Retractable 5-in-1 ABS and bamboo cable. One end is USB-C with adapter for USB-A, while the other end has a special 2-in-1 micro USB and iOS tip with an adapter for USB-C. Input/output: 5V/1A. Supplied in a kraft paper gift box.

40 x 130 mm | Unfolded size: 40 x 850 mm |

Box: 75 x 75 x 250 mm

LSR, PDP



150



Venter 97436 / 97569

Bamboo USB Flash Drive. Supplied in a kraft paper box.

97436: capacity 8GB. Colour: 150

97569: capacity 16GB. Colour: 150

60 x 19 x 10 mm | Box: 90 x 40 x 22 mm

LSR, DUV, PDP, SCR



160



Lange 97132

Bamboo wireless charger and smartphone holder. It has a wireless charging power of 10W. Compatible with smartphones with wireless charging technology. The bamboo support consists of 2 disassembled parts. USB-C cable to charge. Supplied in a kraft paper gift box.

± 140 x 80 x 8 mm

LSR, PDP, SCR



160



Leavitt 97940

Bamboo dual coil wireless charger with pen holder. With fast charging power mode of 10W and 5V/2A and 9V/1.67A input. Includes 1 m USB type C charging cable. Supplied in a kraft paper gift box.

± 77 x 71 x 118 mm

LSR



Mott 97911

Bamboo and ABS office organizer. With wireless charger, USB hub and phone holder. 5V and 1.5A input. Maximum output power of 5W. 1 USB port and 1 USB type C port. Includes 90 cm USB/type C charging cable. Compatible with smartphones with wireless charging technology. Supplied in a kraft paper gift box.

± 255 x 135 x 14 mm

PDP, LSR



160



160



SUPER FAST

Dalton 97123

Bamboo wireless charger with hub function. It contains 2 USB-A output and 1 USB-C input. It has a wireless charging power of 15W. Compatible with smartphones with wireless charging technology. Includes USB-C cable to charge the battery. Supplied in kraft paper gift box.

± 93 x 93 x 9 mm

LSR



SUPER FAST

Daimler 97128

Magnetic fast wireless bamboo charger. 15W fast charging power. Includes a 1 meter cable with a USB-C output. Supplied in a kraft paper gift box.

± Ø59 x 8 mm

LSR, PDP



160

SUPER FAST





Gaming equipment

The devices you need to win in the online world.

Up to **7200 DPI**



103

Thorne Mouse RGB 97133

ABS and rubber finish gaming mouse with 7 buttons and RGB lighting with 8 possible modes. Ergonomic shape designed for comfort and performance during prolonged use. High precision settings up to 7200 DPI. Sturdy 1.5 metre nylon cord. Supplied in a gift box.

124 x 71 x 39 mm

LSR



103

Thorne Mousepad RGB 97134

Polyester gaming mat with non-slip rubber base. RGB peripheral lighting, configured in 15 modes, provides a better gaming experience. These lights can be configured manually, allowing you to set your favourite pattern. Durable 1.5 metre cable designed for prolonged use. Supplied in a gift box.

250 x 350 x 4 mm

TRD, PDP, TRS



Connection via USB-A and **3.5 mm** jack

103

Thorne Headset RGB 97135

Gaming headphones with built-in high-quality microphone and RGB lights with one mode. Designed for prolonged use, they are resistant, comfortable and have a 2 m cable with volume control. Includes 3.5 mm jack cable with USB-A input. When used with this cable, the headphones provide superior audio quality. Supplied in a gift box.

20 x 19 x 10 mm

PDP





106

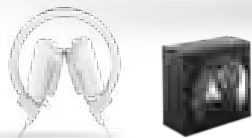

Baron 97365

Foldable and adjustable ABS headphones with padded ear cups for comfort. Features BT transmission and TF card reader. The headphones have autonomy up to 4 hours and the following functions: call answering, volume control and easy mobile device playlist and FM radio connection. They include a USB cable for charging and are supplied in a gift box.

Folded: 165 x 135 x 70 mm | Box: 150 x 150 x 70 mm

PDP



106



Goodall 97321

Foldable and adjustable ABS headphones. These headphones contain 1.45m cable with 3.5mm stereo connection. Supplied in a gift box.

Folded: 100 x 155 x 50 mm | Box: 110 x 170 x 70 mm

PDP SCR



103



106



Volta 97331

ABS adjustable headphones that include 1.20m cable with 3.5 mm stereo connection.

Folded: 150 x 165 mm

PDP



USB A connection



Volume control



Kilby 97088

ABS and PP adjustable headphones with microphone. Includes a 4-button sound control: volume up/down, microphone off and mute. 20Hz-20KHz frequency response, 32Ω impedance, 1,85 m cable and USB A connection. Supplied in a gift box.

170 x 185 x 75 mm

DOM



Gerst 97089

ABS headphone stand with built-in wireless charger. 10W power. USB-C input with 5V/2A or 9V/1.1A and wireless output with 5V/1A or 9V/1.1A. USB-C cable to charge. Supplied in a gift box.

Ø160 x 257 mm | Box: 175 x 47 x 344 mm

PDP



Presley 97139

ABS earphones with built-in microphone, 1.20 m cable with USB-C connection. Features voice pick-up button for calls, 2 pairs of silicone adapters in two different sizes. The headphones are presented in a PS and ABS box with a transparent lid.

Box: 70 x 70 x 180 mm

SCR, DUV



Germain 97358

ABS earphones with 1.2m cable and 3.5mm stereo connection. These headsets are supplied in PP box.

Box: Ø55 x 20 mm

PDP, DUV, SCR

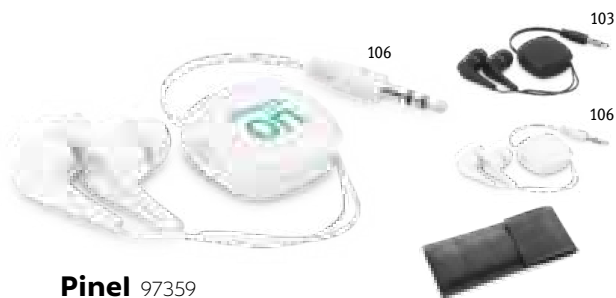

Pinel 97359

Retractable earphones, with 0.75m cable with 3.5mm stereo connection and supplied in a non-woven pouch.

Box: 30 x 38 x 11 mm | Pouch: 60 x 105 mm

PDP, DOM, TRD, TRS

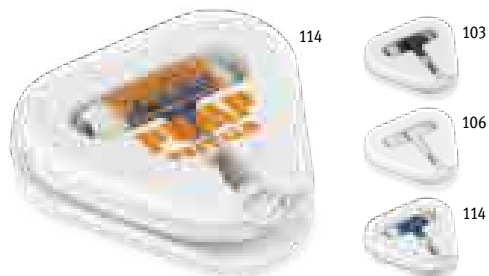

Faraday 97360

Headset with 1.25m cable and 3.5mm stereo connection. These headsets are supplied in PS/ABS box.

Box: 60 x 64 x 16 mm

PDP, DUV, SCR



Otto 97913

PC magnetic earphones. BT 4.1 transmission with up to 3 hours of autonomy. The earphones are capable of answering calls, control volume and connect to the playlist of a mobile device. Includes USB cable for charging. Supplied in an EVA pouch.

Box: 80 x 65 x 32 mm

SCR, DUV





Kandel 97912

ABS wireless stereo earphones. BT transmission, with autonomy of up to 6 hours. Functions: answering calls, control volume and connect to the playlist of a mobile device. Includes USB charging cable. Supplied in a box with charger function.

Headphone: 71 x 55 x 28 mm |
Headphone: 47 x 21 x 21 mm

PDP, DUV



Klebs 97085

True Wireless ABS earphones with microphone and charging box of 250 mah. Autonomy up to 1.5h, frequency 20Hz-20KHz, 98 dB and impedance of 32Ω. Each earphone has a multifunction button. USB cable to charge. Supplied in a gift box.

Headphone: 47 x 19 x 8 mm |
Box: 55 x 64 x 26 mm

PDP

103



106



Chargaff 97210



ABS wireless earbuds that allow BT transmission and have autonomy up to 1.5 h. The earbuds allow you to answer calls, control volume and connect to your mobile device's playlist. Includes USB cable for charging and are supplied with charging base and gift box.

Headphone: 27 x 20 x 28 mm | Base: 77 x 60 x 29 mm |
Box: 83 x 83 x 40 mm

PDP, SCR

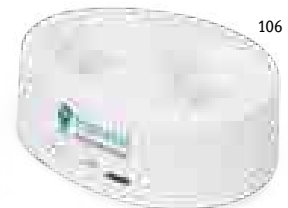

Boson 97934



ABS wireless stereo earbuds with 5.0 BT transmission, built-in microphone and autonomy up to 3h. The charging box, with a 240 mAh battery, is also in ABS and contains a silicone clip that allows you to carry and charge the earphones in an easy and comfortable way. USB cable to charge. Supplied in a kraft paper gift box.

Headphone: 77 x 36 x 30 mm

PDP, DOM





Extend unique moments and experiences with technology. The premium quality and contemporary aesthetics of ekston® translates into products of exceptional performance that accompany us everywhere – an extension of experiences that exalts emotions and challenges the limits of technology.

Know more online

ekston.com



CHARACTERISTICS:

- Microphone
- Button to answer calls
- Connection to mobile device playlist
- Charging box

Descry 97922

The Descry are metal and ABS earphones that are bold and distinctive. Their technical characteristics elevate it to a highly functional object. The Descry are supplied in a gift box.

± 31 x 78 x 38 mm | Charging box: 79 x 40 x 32 mm |
Box: 128 x 110 x 58 mm

➤ PDP



103

Vibe 97954

Vibe are true wireless ABS earphones with BT 5.0. Perfect to carry anywhere as the storage case also serves as a charger. Never run out of music in your daily life or worry about the rain, as they are water resistant. USB cable to charge. Supplied in a gift box.

± 69 x 42 x 25 mm

➤ PDP

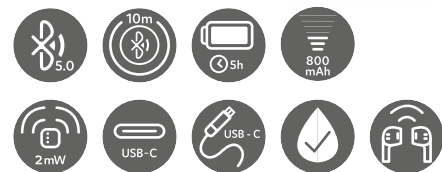

CHARACTERISTICS:

- ⦿ Microphone
- ⦿ Touch control
- ⦿ LED indicator
- ⦿ Connection to mobile device playlist
- ⦿ Charging box



103



Bass 97955

Bass are true wireless earphones with 5.0 BT. The storage case is also a charger, which makes Bass practical and easy to take everywhere. Supplied in a gift box.

± 68 x 39 x 28 mm

➤ STI

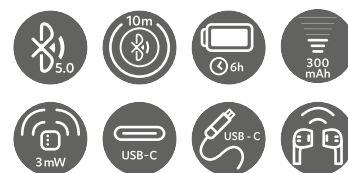

CHARACTERISTICS:

- ⦿ Connection to mobile device playlist
- ⦿ Charging box



103



Hearkeen 97919

The Hearkeen are versatile ABS and silicone earphones, perfect for different everyday moments. Due to their versatile design, they can be used in more professional environments, or for sports.

± Earphones (each): 33 x 16 x 24 mm | Neck band length: 455 mm | Box: 201 x 220 x 40 mm

➤ PDP



CHARACTERISTICS:

- Microphone
- Button to answer calls
- Volume control
- Connection to mobile device playlist

107



Vibration 97923

The Vibration are metal and ABS modern designed earphones that stand out for their metallic finished in the different details of the product. The Vibration are supplied in a gift box.

± 20 x 18 x 20 mm | Box: 88 x 97 x 45 mm

➤ LSR



CHARACTERISTICS:

- Microphone
- Button to answer calls
- Connection to mobile device playlist

Melody 97957

The Melody are foldable PU wireless headphones with BT 5.0 connection. Modern and original, Melody are perfect to listen to your favourite music. Supplied in a gift box.

± 190 x 205 x 50 mm

LSR

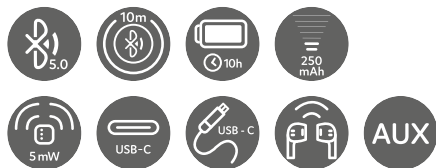

CHARACTERISTICS:

- Foldable
- Microphone
- Volume control
- Connection to mobile device playlist
- Cable included



103

Beatdrum 97956

Beatdrum are foldable wireless headphones in ABS and fabric with 5.0 BT connection. Beatdrum's finish is rubberized and completed with fabric details. Ideal to complete any style. Supplied in a gift box.

± 95 x 155 x 52 mm

TRS, TRD



CHARACTERISTICS:

- Foldable
- Microphone
- Volume control
- Connection to mobile device playlist
- Cable included



133

4 in 1

- + Speaker
- + Wireless charger
- + LED light
- + mobile phone holder



Blasty 97960

Blasty is a ABS, PP and fabric 4-in-1 speaker. With an irreverent and bold design, this speaker can also be used as a wireless charger, mobile phone holder and a lamp. Supplied in a gift box.

∅205 x 50 mm
PDP, SCR



CHARACTERISTICS:

- Touch button
- LED light
- 3 levels of intensity
- Cable included

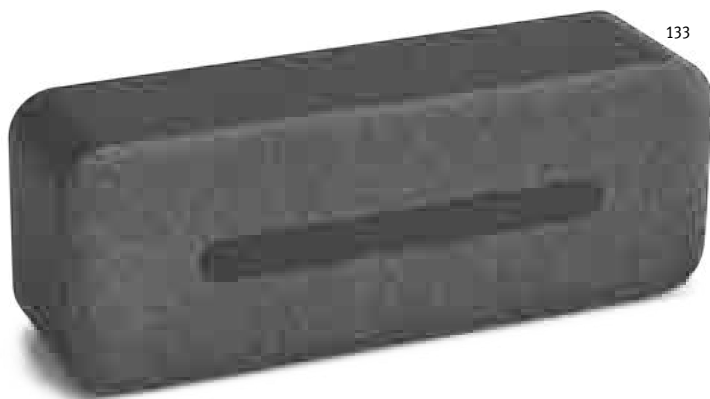

Thunder 97258

The Thunder is a textured fabric ABS speaker elegant and with detailed finishings. The speaker is an object that fits perfectly into a stylish and sophisticated environment and is supplied in a gift box.

73 x 196 x 54 mm | Box: 275 x 123 x 74 mm
SCR



CHARACTERISTICS:

- Microphone
- Button to answer calls
- Volume control
- Connection to mobile device playlist

Panoramic design on all **4** sides



LED **Burmy**
97959

The Burmy is a PP, ABS and metal aroma diffuser with interior light. The light has several colour options, so you can choose the one which suits your mood (aroma not included). Supplied in a gift box.

± 98 x 175 x 98 mm

➤ **SCR**



CHARACTERISTICS:

- ⊙ Aromatherapy
- ⊙ LED light
- ⊙ 3 levels of intensity



LED **Soleil**
97958

Soleil is an alarm clock with a touch front panel. Besides radio function, it has a light simulating sunrise which increases gradually until it reaches a bright yellow light and natural sounds, ideal for a peaceful and pleasant awakening. Supplied in a gift box.

± Ø170 x 40 mm

➤ **PDP, DUV**



CHARACTERISTICS:

- ⊙ 6 natural sounds
- ⊙ 15 volume levels
- ⊙ Various coloured light options
- ⊙ LED light
- ⊙ Front touch panel
- ⊙ Includes micro USB cable and adapter

Light simulation of sunrise





103

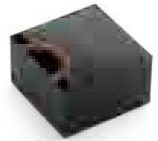

Impera II 97428

Impera II is a smartwatch with a silicone strap and touchscreen display. Compatible with the main operating systems, this watch will help you manage your daily life. Supplied in a gift box.

± Ø48 x 250 x 21 mm
✓ LSR



CHARACTERISTICS:

- ⊙ Sports menu
- ⊙ Mobile device notifications
- ⊙ Heartbeat rate sensor
- ⊙ Sleep monitoring
- ⊙ Connection to mobile device playlist



101

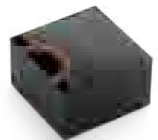

Impera 97427

Impera is a smartwatch with a PU strap and touchscreen display. Compatible with the main operating systems, this watch will help you manage your daily life. Supplied in a gift box.

± Ø48 x 260 x 22 mm
✓ LSR



CHARACTERISTICS:

- ⊙ Sports menu
- ⊙ Mobile device notifications
- ⊙ Heartbeat rate sensor
- ⊙ Sleep monitoring
- ⊙ Connection to mobile device playlist



From the office to training: track all your movements with our smart devices



103

Calatrava 97130

ABS and TPU smartwatch with LCD display and touch screen. The battery has a capacity up to 90 mAh, autonomy up to 3 days (standby up to 5 days). Includes indicators for distance, steps, calories, heart rate, blood pressure, oxygen level, sleep monitoring, calls, text messages, app notification and sports mode. Compatible with software IOS 9.0, Android 5.0 and above. LED display- 80 x 160 resolution. Supplied in a gift box.

137 x 82 x 28 mm

 PDP



103

Wiles 97136

Smartwatch with 1.85-inch IPS screen and silicone strap. Battery capacity up to 200 mAh. The BT connection allows you to connect your mobile phone to the bracelet, as well as to the "Fitpro" app - compatible with IOS and Android. This smartwatch includes an alert for incoming calls and sports features such as sleep monitoring, heart rate, blood pressure, blood oxygen, stopwatch and pedometer. It is also splash-proof and features a flashlight, remote camera, alarm, anti-lost system and music player. This smartwatch is ideal for accompanying you in everyday life. Supplied in a gift box.

45 x 40 x 13 mm

 LSR



Florey 97252



Aluminium speaker with microphone, BT transmission and TF card reader, 3W/4 power and autonomy up to 3h. Functions: answering calls, volume control, connection to mobile device's playlist and FM radio. This product includes USB cable for charging and is supplied in a gift box.

∅71 x 42 mm | Box: 80 x 80 x 60 mm

LSR, LAS, PDP



Perey 97253



Rubber-finished ABS speaker with microphone, BT transmission, TF card reader and 3W/4Q power. This speaker has autonomy up to 2 h and functions such as answer calls, control the volume and connect to the mobile device playlist. This product includes USB cable for charging.

∅59 x 55 mm

PDP

Waterproof

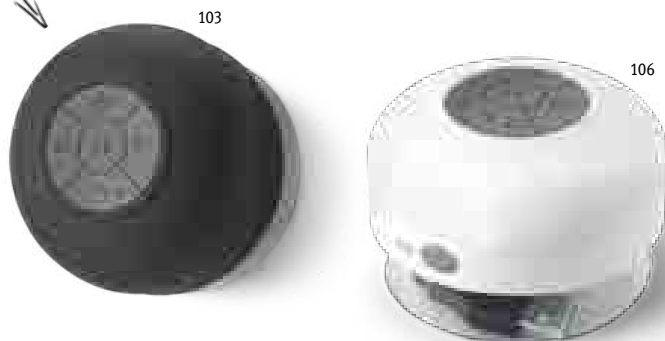

Curie 57328



ABS waterproof wireless speaker with a matte finish. BT transmission, 3W power (4Q) and autonomy for up to 3 hours. Functions include: connectivity to devices, call answering, volume control, suction pad and charging cable. Supplied in a gift box.

∅85 x 50 mm | Box: 88 x 88 x 55 mm

PDP





Carrying handle

113

Gante 97395

Speaker with microphone in ABS, polyester fabric and rubber finish. This speaker allows BT transmission, 3.5mm stereo connection and TF card reading. It has 3W/4Q and autonomy up to 2 h. Answer calls, control volume, connect to mobile device's playlist and FM radio are some of the features of this speaker. The speaker includes a USB cable for charging and is supplied in a gift box.

120 x 80 x 40 mm | Box: 142 x 85 x 45 mm

DUV



113

Teds 97208

Speaker with microphone in ABS, polyester fabric and rubber finish. This speaker allows BT transmission, 3.5mm stereo connection and TF card reading. It has 2 x 3W/4Q and autonomy up to 4 h. The speaker allows the function to answer calls, control the volume and connect to the mobile device playlist. Includes USB cable for charging and is supplied in a gift box.

160 x 120 x 50 mm | Box: 180 x 180 x 66 mm

SCR, TRD, TRS



Wireless charger



103

Grubbs 97933

ABS speaker with rubber and fabric finish on the front. With a sophisticated design, this speaker has an autonomy up to 2h, with 5.0 BT transmission and 3W power. It also has a wireless charger feature, with a 5W power, with 5V/2A input and 300 mAh battery. It includes a USB charging cable. Supplied in gift box.

108 x 56 x 54 mm

DOM



103

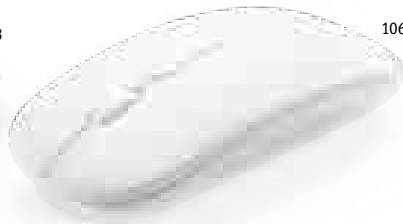

106



Khan 97129

2.4GhZ ABS (89% rABS) wireless mouse with ergonomics optical technology with a rubber finish. Includes battery with 500 mAh capacity. Includes USB cable for charging. Supplied in a kraft paper gift box.

112 x 58 x 23 mm

PDP



113



114

Crick 97398

2.4GhZ wireless mouse in ABS with rubber finish. Includes 2 AAA batteries.

65 x 105 x 20 mm

PDP



103



106



Blackwell 97304

2.4GhZ wireless mouse in ABS. Includes 2 AAA batteries. Supplied in a clear box.

57 x 113 x 20 mm | Box: 64 x 120 x 36 mm

PDP, DUV, SCR



106



Blair 93282

Mousepad for sublimation with rubber base.

230 x 200 mm

SUB

Wheat Straw Collection



160

Englert 97932

Wheat straw fiber and ABS mobile phone holder with dual coil wireless charger. With a fast charging power of 10W and with 5V/2A and 9V/1.67A inputs. Includes USB cable to charge. Supplied in a kraft paper gift box.

± 70 x 112 x 87 mm

➤ PDP



160

Feynman 97939

Wheat straw and ABS foldable wireless headphone. Output power of 32mW and BT 5.0 up to 10m range. 400 mAh battery and autonomy up to 4h. Includes AUX port, slot for TF/SD card. Volume control buttons and turn on/off. USB cable to charge. Supplied in a kraft paper box.

± Headphones (closed): 185 x 185 x 74 mm | Box: 120 x 90 x 160 mm

➤ PDP



160

Fourier 97938

Wheat straw fibre and PP True Wireless earbuds with BT 5.0 with 10m range and up to 3h autonomy (standby time up to 10h). Each earbud has a built-in multifunction button and mic, which enables easier hands-free calling, and a LED indicator of battery and charging status. The charging box has a battery with 300 mAh and a LED indicator of battery and charging status. Includes a charging cable with USB-C. Supplied in a kraft paper gift box.

± 80 x 38 x 32 mm

➤ PDP

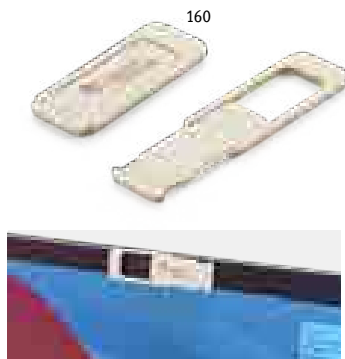

160

Townes 97953

Wheat straw fiber and PP webcam protector with sliding cover and sticker on the back. This protector's size is universal and suitable for smartphone, tablet and laptop.

± 42 x 17 mm | Open: 65 x 17 mm

➤ PDP



160

Cuvier 97929

ABS and wheat straw fiber wireless charger. The charging power is 5W, with 5V/2A input. The base contains a silicone circle so the equipment does not move while charging. Includes USB-C cable for charging. Supplied in a kraft paper gift box.

± Ø70 x 10 mm

➤ PDP

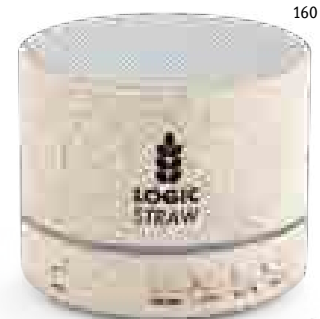

160

Lineu 97930

Wheat straw fiber and ABS speaker with microphone. Speaker with 3W power and 5.0 BT transmission. Contains an autonomy up to 2h and a 300 mAh battery. USB cable to charge. Supplied in a kraft paper gift box.

± Ø62 x 48 mm

➤ PDP



113



Renewal Charger 97093

PET (100% rPET) wireless charger. Charging power is 10W, with 5V/1.6A and 9V/1.5A inputs. USB-C cable to charge. Supplied in a kraft paper gift box.

100 x 62 x 10 mm

STI

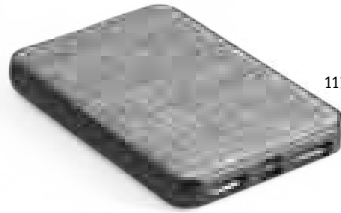

113



Renewal Battery 97094

PET (100% rPET) portable battery, with lithium battery, 5,000 mAh capacity, and 5V/2A input/output. Includes one micro USB port, one USB-C port, and two USB ports. USB-C cable to charge. Supplied in a kraft paper gift box.

65 x 98 x 10 mm

STI

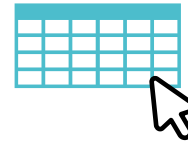

To learn more about other technical features, click here



105



133



103

104

105

127

133

Cassini 97078

Aluminium portable battery and wireless charger. Contains a lithium polymer battery. It contains a capacity of 4,000 mAh and a lifespan of ≥ 500 cycles. 5V/2A input and 5V/2A output, with LED charge indicator. USB cable to charge. Supplied in a gift box.

123 x 70 x 10 mm

LSR, DUV, PDP, SCR



127

Fermat 97343

Aluminium portable battery with lithium battery with a capacity of 7,200 mAh and a life span of approximately 500 cycles. 5V/1A input/output. USB-C cable to charge the battery. Supplied in a gift box.

90 x 77 x 22 mm | Box: 110 x 85 x 25 mm

LSR, PDP, SCR



124

127

103

Marcet 97344

Aluminium portable battery with lithium battery, capacity of 4,000 mAh and lifetime over 500 cycles. This battery has 5V/1A input/output, includes USB-C cable to charge the battery and is supplied in a gift box.

110 x 68 x 10 mm | Box: 115 x 70 x 25 mm

LSR, DUV, PDP, SCR



127

103

Nobel 97351

Aluminium portable battery with lithium battery. This battery has a capacity of 7,200 mAh, lifetime over 500 cycles contains 5V/1A input, 5V/1-2.1A output and 2 USB ports. Includes USB cable to charge the battery and is supplied in a gift box.

150 x 74 x 12 mm | Box: 165 x 80 x 20 mm

LSR, DUV, PDP, SCR

16.000 mAh capacity

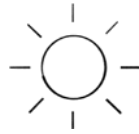

Clean energy



Take advantage of the sun to charge all your devices



103

127

103

127

LED **Raman** 97905

ABS portable battery. Contains a lithium battery with a capacity of 16,000 mAh and a lifespan of over 1,000 cycles. It has a 5V/1.8A input, 5V/1-2.1A output, charge indicator, 2 USB-A output ports, 1 micro-USB port and 1 USB-C input port. The battery is protected against overcharging, short-circuiting, and overheating. Includes USB-C charging cable. Supplied in a gift box.

156 x 80 x 23 mm | Box: 175 x 100 x 30 mm

SCR, DUV

127

103



Clerk 97137

Portable battery made of aluminium (100% recycled) and lithium battery. The battery includes a solar panel and torch. It has a capacity of 8,000 mAh and a lifespan of over 500 cycles. It has USB-C input and USB-C and USB-A output for charging the battery. Includes a 30 cm USB-A/USB-C charging cable. Ideal for emergency situations. Supplied in a kraft paper gift box.

153 x 74 x 10 mm

LSR, SCR



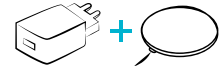
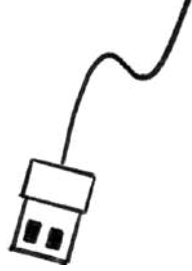

Pair with quick chargers

97907 / 97908 / 97123

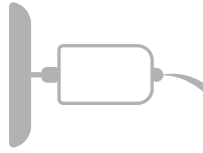

106

Woese 97361

ABS USB adapter with 5V/1A output.

⊕ 48 x 35 x 14 mm

🔧 PDP, DUV



106



Redi 97362

ABS USB adapter with 2 5V/1-2.1A output.

⊕ 62 x 42 x 23 mm

🔧 PDP, DUV



106



Houston 97160

Qualcomm 3.0 ABS adapter with USB 2.0 port. The charger has input of 100V-250V/0.35A and output of 5V/3.1A, 9V/2.0A, 12V/1.5A with 18W power.

⊕ 42 x 25 x 85 mm

🔧 PDP, DUV

Stay connected

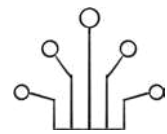

127

Minsky 97090

Aluminium adapter set that contains 1 adapter from USB-A to USB-C and 1 adapter from USB-C to USB-A. USB 2.0 technology. Supplied in individual PP case.

⊕ 37 x 40 x 18 mm

🔧 PDP, DUV, SCR



114

Emmy 97153

3 in 1 USB cable in ABS and PVC. This cable is suitable for charging mobile devices: it has a Type C USB connector and a 2 in 1 connector. It is compatible with micro USB inputs and iOS operating system. Supplied in a PP box.

⊕ Box: Ø53 x 20 mm

🔧 PDP, DUV



106

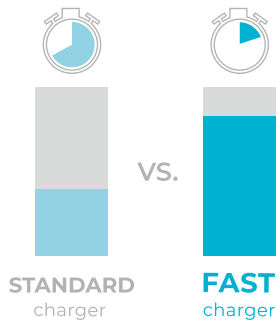

SUPER FAST

Pair with adapters

97160 / 97362



Burnell 97908

ABS wireless fast charger with rubber finish. Has a 5V/2A and 9V/1.67A inputs and has 10W charging power. Includes USB charging cable. Compatible with smartphones with wireless charging technology.

∓ Ø99 x 9 mm | Cable: 1000 mm

➤ LSR

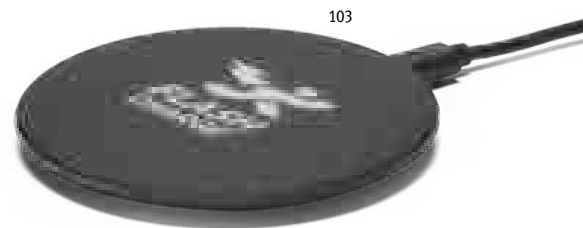

103



106



103



106



Caroline 97903

Wireless charger and USB 2.0 hub in ABS. This product allows to charge the device by induction, has 5V/2A input, 5V/0.5-1A output, 2 outputs USB-A, input USB-C and 5W charging power. Compatible with smartphones with wireless charging technology. Includes USB-C cable for charging

∓ 90 x 90 x 10 mm

➤ PDP, DUV, SCR

Joule 97907

Aluminium and ABS wireless charger. Includes a 1 m USB-C cable for fast charging. The charger has 5V/2A and 9V/1.67A inputs and 5V/1A and 9V/1A outputs with a charging power of 10W. Compatible with smartphones with wireless charging technology. Includes USB-C cable for charging. Supplied in a gift box.

∓ Charger: Ø98 x 6 mm | Cable: 1000 mm

➤ PDP, DUV

Complete your desk

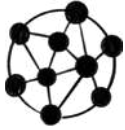

127

Henry 97060

Digital table clock with calendar. Includes 1 LR44 battery.

± 105 x 30 x 27 mm

➤ PDP, DUV



103



106

Jannes 97318

USB 2.0 hub with 4 ports to connect up to 4 mobile devices.

± 52 x 41 x 12 mm

➤ PDP, DUV



103



105



114

Gardner 97357

USB 2.0 hub in ABS, with 4 ports.

± Ø52 x 18 mm

➤ PDP, DUV



127

Dene 97070

Aluminium desk station with LCD screen. This station has calendar, alarm and weather information and forecast. Includes 2 AAA batteries.

± 130 x 130 x 19 mm

➤ LSR, PDP, SCR



127

Edem 97065

Acrylic pen holder with calendar, alarm and thermometer. Includes 1 CR2025 battery.

± 95 x 118 x 50 mm

➤ PDP, DUV



127

Enfield 97765

8-digit dual-power calculator that includes 1 AG10 battery.

± 151 x 112 x 28 mm

➤ PDP



Grahame 94744

ABS Desk lamp with speaker. This lamp includes 18 high-brightness LEDs, tactile button and flexible arm and BT transmission. Comes with 3.5 mm stereo connector with 5W/4Ω and has autonomy up to 6 hours. It also allows a connection to the mobile device's playlist and includes USB-C cable to charge.. This product is supplied in a gift box.

100 x 225 x 100 mm | Box: 110 x 235 x 105 mm

PDP



Nesbit II 97141

Portable table lamp in ABS (65% rABS) with 140 lumens and a clip to hold it to surfaces. The base is non-slip and the tube can be swivelled 360° to easily adjust the direction of the light. It has a built-in 1200 mAh lithium battery. It has an on/off switch with 3 brightness levels: high light (approximately 3 hours of use), medium light (approximately 7 hours of use) and low light (approximately 30 hours of use). Includes USB-C cable for recharging the battery. Supplied in a kraft paper gift box.

122 x 58 x 456 mm

PDP



Simon 8Gb 97434
 Mini 8 GB UDP Pen Drive in aluminium. Supplied in a PP box.
 33 x 12 x 6 mm | Box: 68 x 25 x 15 mm
 LSR, PDP



Boyle 8Gb 97435
 8 GB USB Flash Drive with metal clip. Supplied in a PP box.
 55 x 17 x 8 mm | Box: 68 x 25 x 15 mm
 LSR, PDP



Claudius 32Gb 97546
 32 GB USB Flash Drive with rubber finish and metal clip. Supplied in a box.
 56 x 19 x 10 mm | Box: 86 x 45 x 20 mm
 LSR, PDP, SCR

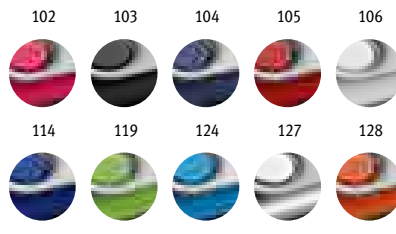

Claudius 97548 / 97549 / 97433
 USB flash drive with different capacities with rubberised finish and metal clip. Supplied in box.
 97548: capacity 4GB. Colours: 103, 104, 105, 106, 119, 124 and 127.
 97549: 8GB capacity. Colours: 102, 103, 104, 105, 106, 119, 124, 127 and 128.
 97433: capacity 16GB. Colours: 103, 105, 106, 114, 119, 124 and 127.
 56 x 19 x 10 mm | Box: 86 x 45 x 20 mm
 LSR, PDP, SCR

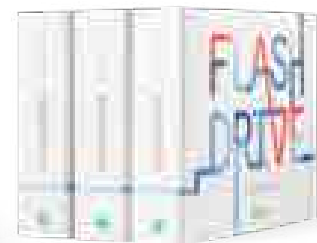

70070
 Showcase available online

With carabiner



Bragg 8Gb 97438
8GB USB flash drive in PU and with carabiner clip. Supplied in a gift box.
⊥ 100 x 26 x 11 mm | Box: 115 x 60 x 25 mm
✔ LSR, HTS, PDP

103



Savery 97524
ABS ball pen with metal clip and 4GB UDP memory. UDP memory can be stored inside the ball pen. Supplied with gift box (disassembled).
⊥ Ø12 x 144 mm | Case: 150 x 15 x 19 mm
✔ PDP, HTS, SCR

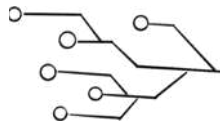

Wallace 8Gb 97437
8GB UDP Pen Drive in ABS, in card format.
⊥ 86 x 54 x 3 mm | Box: 103 x 72 x 10 mm
✔ PDP, DUV, SCR

106

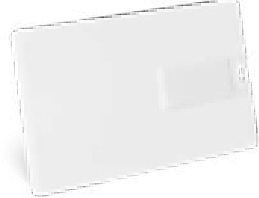

103



104



Avery 92352
Soft shell pouch for laptop up to 14\"/>
⊥ 355 x 280 x 30 mm
✔ TRS, TRD



104



Planck 97156
 Aluminium car phone holder. Includes a magnetic metal piece with 360° swivel frame which allows for optimal phone positioning. Sticky pad provided to place on the phone.
 ⚓ Ø35 x 44 mm
 ⚡ LSR



Euler 97338
 ABS car phone holder, can be attached to the vent with a simple touch. Holds your phone securely during your car journey.
 ⚓ 50 x 97 x 28 mm
 ⚡ PDP, DOM



Pauling 97316
 ABS USB car adapter with 2 5V/1-2.1A outputs. Suitable for charging mobile devices.
 ⚓ 37 x 80 x 26 mm
 ⚡ PDP



103 105 106 114 128



Carver 93321
 Silicone smartphone card holder with a sticker on the back and flexible support.
 ⚓ 57 x 96 x 5 mm
 ⚡ SCR

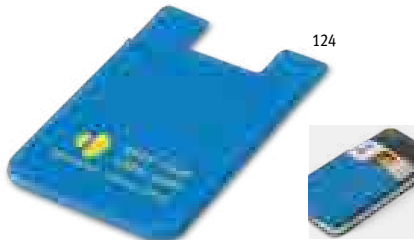

103 105 106 114 124 128



Shelley 93320
 Silicone smartphone card holder with a sticker on the back.
 ⚓ 57 x 87 x 3 mm
 ⚡ SCR



103 105 106 114 119



Hooke 97367
 ABS and TPR mobile phone holder.
 ⚓ Closed: 89 x 30 x 9 mm
 ⚡ PDP, DUV, SCR

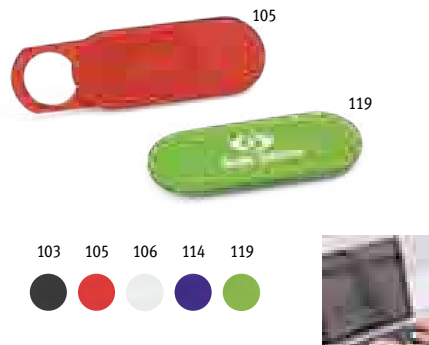

103 105 106 114 119



Hide 57951
 PP webcam protector with sliding cover and sticky pad to back. Universal format suitable for smartphone, tablet and laptop.
 ⚓ 43 x 13 mm | Closed: 32 x 13 mm
 ⚡ PDP, DUV



Thom 99016
 Ⓜ .294

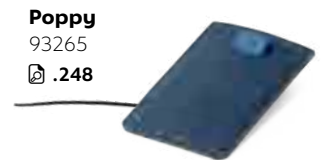

Poppy 93265
 Ⓜ .248

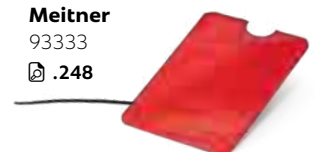

Meitner 93333
 Ⓜ .248

OFFICE



Emerge Collection

A collection that combines sustainability with technology.



104



Emerge Folder II 93580

300D PET (100% rPET) A4 folder with elastic closure. 210D PET (100% rPET) lining with multiple pockets, pen holder (pen not included) and a notepad with 20 white lined sheets from sustainable forest management. Supplied in a non-woven pouch.

230 x 330 x 50 mm

TR5 TRD



104



Emerge Folder 93579

300 D PET (100% rPET) A4 folder with zipper. 210D PET (100% rPET) lining with multiple pockets, smartphone compartment up to 6.5", pen holder (pen not included) and a notepad with 20 white lined sheets from a sustainable forest management. Supplied in a non-woven pouch.

250 x 340 x 40 mm

TR5 TRD



Wireless charger



103



A5 Emerge A5 Folder 93581

300D PET (100% rPET) A5 folder with built-in wireless charger. The battery has a capacity of 5.000 mAh, 5 W power, 5V/2.1A input/output and a USB type C cable to charge it. The folder contains a smartphone pocket inside for a device up to 6.5", 3 card slots, 4 LED lights, an on/off button, a ball pen holder (not included), a smartphone and USB cable, a notepad with black cardboard cover and 64 ivory-colored sheets from sustainable forest management. On the front, there is also an oval print in black to indicate the wireless charging area. Supplied in a gift box.

165 x 225 x 25 mm

SCR, TRD, TRS



103

A4 Paszo 92044

PU and microfibre A4 folder with several interior pockets, 20 lined sheets pad and a pen holder (not included). Plate available for customization.

245 x 325 x 40 mm | Plate: 16 x 45 mm

LSR, TRD, TRS



123

A4 Auster 92073

A4 folder in 600D with exterior pocket to front. An internal ringbinder of 4x20 mm rings enable organisation of A4 sheets. This folder also contains a 20 sheet pad of lined paper, a pen holder (pen not included) and compartments for accessories (not included).

260 x 340 x 35 mm

TRS, TRD



128



103

105

119

123

124

128



103

104



A4 Fitzgerald 92040

A4 folder in PU and 800D with microfibre interior, with elastic band closure. Contains a 20 sheet pad with lined paper, 3 pockets and a pen holder (pen not included).

245 x 315 x 15 mm

TRS, TRD

A4 Cussler 92049

A4 folder in 600D includes a 20 sheet pad with lined paper, an inner pocket and pen holder (pen not included).

240 x 320 x 10 mm

TRS, TRD



123

104



A4 Riordan 92067

A4 imitation linen and PU folder. Features a magnetic closure with a customisable plate, a 20 sheet pad of lined paper, pen holder (pen not included), smartphone pocket and brackets for cables or other accessories (not included).

233 x 310 x 18 mm | Plate: 50 x 30 mm

LSR, TRD, TRS

A5 Pynchon 92066

A5 folder in imitation linen and PU. Features a magnetic closure with a customisable plate. This folder includes a pad of 20 sheets of lined paper, support for ball pen (not included) and other compartments for accessories (not included).

183 x 252 x 18 mm | Plate: 50 x 30 mm

LSR, TRD, TRS



160



160



160



A4 Puzo 93463

A4 Kraft paper document folder (400 g/m²) with two inner pockets.

230 x 307 mm

SCR, TRD, TRS



A4 Poe 92046

A4 Kraft paper document folder (450 g/m²) with a 20 sheet pad of recycled plain paper (60%) and a business card holder. Ballpoint included.

230 x 320 x 15 mm

PDP, DUV, SCR, TRD, TRS



A4 Serpa 92069

Cork A4 folder, with a 20 plain ivory sheets pad, pen holder (pen not included) and elastic. Supplied in a non-woven pouch.

239 x 307 x 17 mm | Pouch: 285 x 350 mm

LSR, SCR, TRD, TRS



A5 Freud 93578

Set of A5 notepad and cork ball pen. Notepad with 192 lined ivory pages from a sustainable forest management. Ball pen with blue ink. Supplied in a kraft paper gift box.

140 x 210 mm
LSR, SCR, TRD, TRS

Cork

The uniqueness of a noble and natural material like cork is the perfect way to spread brand awareness.



B6 Vicente 93285

B6 notepad with hard cover made of cork and PET (50% rPET) with 140 plain pages made of recycled kraft paper (100%) (70 g/m²) Includes a pen holder and a ball pen in wheat fibre and ABS with clip. Blue writing.

Notebook: 130 x 178 mm | Ball pen: Ø10 x 141 mm
SCR, LSR

Goya
 91795
 .69

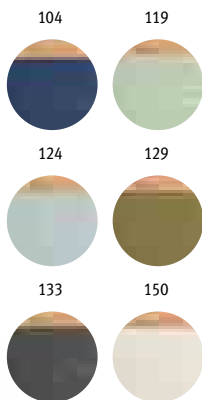

A5 Klee 93277

A5 notepad with cork cover and linen at the bottom of the cover. This notepad has 192 lined ivory pages from a sustainable forest management and pen holder (pen not included). Supplied in kraft paper envelope with customisable sticker.

140 x 210 mm
LSR, DUV, SCR, TRD, TRS



A6 Adams A6 93720

A6 cork notepad with plain ivory pages and bookmark ribbon.

90 x 142 mm
LSR, SCR, TRD, TRS



A5 Adams A5 93719

A5 cork notepad with 160 plain ivory pages and bookmark ribbon.

140 x 210 mm
LSR, SCR, TRD, TRS



Re-Lando Set
91778
.65

140 pages recycled paper



A5 Dickens A5 93485
Bamboo hardcover A5 spiral-bound notepad, 140 lined recycled pages (100%) and pen holder (pen included).
135 x 180 mm
PDP, LSR, SCR







A5 Orwell 93281
A5 notebook with rigid cover in bamboo and cork sheets. Contains 160 pages, made of 100% recycled paper, ivory-coloured lined, separator strip, elastic band and pen holder (pen not included).
140 x 210 mm
SCR, LSR



Tree-free paper

Zero waste

-  COVERS MADE OF NATURAL MATERIALS
-  CHEMICAL- AND ACID-FREE PAPER
-  EACH BLOCK SAVES UP TO 9 LITERS OF WATER
-  SHEETS FROM RECYCLED COTTON

1 ton of recycled cotton saves:

-  24 TREES
-  957 KG OF CO2
-  65 000 L OF WATER



Elephant Poop

Notepad made from organic elephant matter (95%). The inner paper is made from cotton waste and is highly durable. Contains paper band with artwork. No waste has been generated nor have any chemicals or trees been used in the manufacturing process of this notepad.

A5 Organic Rigid 93294

 A5 with hard cover, 120 lined pages.

A5 Organic Semi-Rigid 93288

 A5 with semi-rigid cover, 100 lined pages.

A6 Organic Soft 93291

 A6 with soft cover, 52 plain pages.



Tea Leaf Waste

Notepad made from tea leafs waste (65%). The inner paper is made from cotton waste and is highly durable. Contains paper band with artwork. No waste has been generated nor have any chemicals or trees been used in the manufacturing process of this notepad.

A5 Teapad Rigid 93296

 A5 with hard cover, 120 lined pages.

A5 Teapad Semi-Rigid 93290

 A5 with semi-rigid cover, 100 lined pages.

A6 Teapad Soft 93293

 A6 with soft cover, 52 plain pages.



Coffee Husks

Notebook made from coffee husk waste (65%). The inner paper is made from cotton waste and is highly durable. Contains paper band with artwork. No waste has been generated nor have any chemicals or trees been used in the manufacturing process of this notebook.



A5 Coffeepad Rigid 93295

A5 with hard cover, 120 lined pages.

A5 Coffeepad Semi-Rigid 93289

A5 with semi-rigid cover, 100 lined pages.

A6 Coffeepad Soft 93292

A6 with soft cover, 52 plain pages.



Stone Paper:

- Soft texture
- Resistente à água
- Resistant

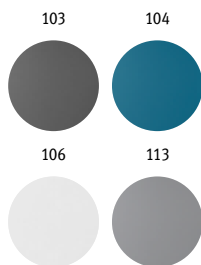

A5 Queiros 93283

A5 water-resistant 100% stone paper soft cover notepad (620g/m²) with 128 stone plain paper pages (120g/m²).

140 x 210 mm

SCR



A5 Crane 93284

A5 Hard Cover, water-resistant notepad. Contains 128 lined pages (120g/m²) in 100% stone paper.

150 x 210 mm

SCR, DUV, HTS

Recycled leather

Made out of used furniture, clothing or shoes, as well as the leather leftovers from other products.



With inner pocket



111

103



A5 **Matisse** 93087

A5 notepad in recycled leather (75%) with 192 lined ivory pages from a sustainable forest management. Pen holder (pen not included), black elastic band and bookmark ribbon. Contains interior pocket. Supplied in a black card paper envelope.

140 x 210 mm

SCR, HTS, TRD, TRS



131

103

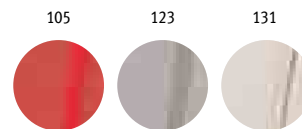
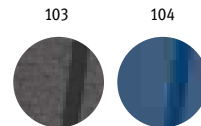

A5 **Boyd** 93276

A5 notepad with PET (50% rPET) hardcover. This notepad has 192 lined ivory pages from a sustainable forest management, bookmark ribbon, elastic band and inner pocket.

140 x 210 mm

TRS, TRD



Recycled milk cartons



A5 **Milky** 93271

A5 notebook with a rigid cover made from recycled milk cartons, helping to reuse the cardboard and aluminium contained in the cartons. Contains 160 pages, 100% recycled paper, ivory-coloured lined, separator strip and elastic band.

145 x 210 mm

SCR, HTS



103

A5 **Rousseau** 93268

A5 notepad with hardcover and rounded corners made from natural straw fibres and cotton canvas. This notepad has 192 lined white pages, bookmark ribbon, elastic band and pen holder (pen not included).

150 x 210 mm

TRS, TRD



160



A5 **Neruda** 93275

A5 notepad with hardcover made from natural straw fibres. Includes a metal plaque that can be customised and added to the cover. This notepad has 192 lined ivory pages from a sustainable forest management.

150 x 210 mm | Plate: 30 x 15 mm

LSR, DUV, SCR



103

Lispector 93724

A5 notepad with PU hardcover and magnetic closure. This notepad has a pen holder (pen not included), 192 plain ivory pages a bookmark ribbon. Supplied in a non-woven pouch.

148 x 210 mm | Pouch: 185 x 240 mm

TR S, HT S, TR D



104

Russel 93788

PU and polyester folder with A5 notepad inside. This folder contains magnetic closure, outer pocket, inner pocket and pen holder (pen not included). The removable notepad contains 160 plain pages. This customisable product is provided in a non-woven pouch.

155 x 215 mm | Pouch: 205 x 250 mm

SCR, TR D, TR S



104



113



103

280
Pages

Shakespeare 93789

A5 notepad with hardcover in PU. This notepad has 280 plain ivory pages, pen holder (pen not included) and elastic band. Supplied in a non-woven pouch.

145 x 210 mm | Pouch: 185 x 240 mm

SCR, DUV, HT S, TR D, TR S



103

104



Moriah 93799

A5 notepad with hardcover in PU. This notepad has 192 lined pages, a pen holder (pen not included) and an elastic band.

140 x 210 mm

LSR, HT S

EUROPEAN DESIGN

THE BRAND THAT MATCHES

Know more online

branve.com

 @branve.official

 @branve_official



Find other BRANVE® products

 .75 Write

 .92 Bags

Empire Collection

92680

92359

92360

 .92



103

A5 Empire Notebook 93598

The EMPIRE is an A5 notepad with a professional, modern and minimalist design and elegant metallic closure. The PU hardcover contains 240 pages, divided equally into plain, lined and dotted paper, from sustainable forest management sources. The three distinct sections have a separator which allows you to easily identify each section. The product is supplied with a pen holder (pen not included) and is supplied in a gift box.

📏 Notepad: 150 x 210 mm | Box: 197 x 28 x 262 mm

🏭 LSR, HTS



Dynamic Collection

92682

92187

 .96

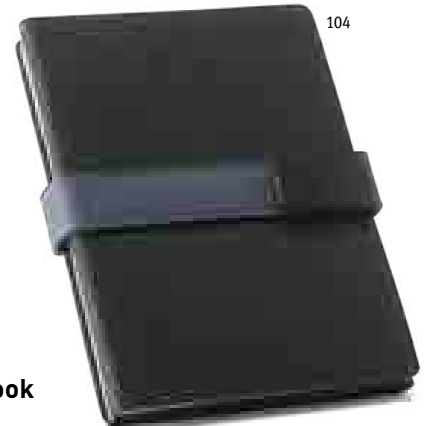

104

A5 Dynamic Notebook 93597

The Dynamic is an A5 notepad though and designed to be a functional and practical object with a touch of city elegance. It has two different writing notepads on each side that can be used and closed separately. It has a magnet closing system on the strap that goes around the notepad. The band has a different colour on each side, allowing its identification, giving a certain irreverence to the product. The exterior material is high quality imitation leather, textured and smooth. It has 256 pages, from a sustainable forest management, that are divided proportionally between plain and lined pages, identifiable by the outer banner. The Dynamic notepad is unique in its design but also in its functionality, where duality makes it a perfect object for every moment of everyday life.

📏 Notepad: 150 x 210 mm | Box: 200 x 30 x 265 mm

🏭 LSR, HTS, SCR

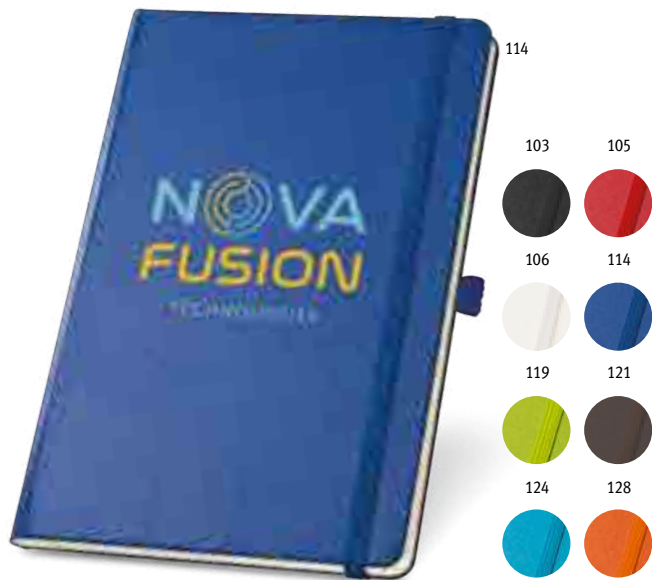

A5 Twain 93494

A5 notebook with 160 lined pages in ivory colour. Includes hard cover, inner pocket, pen holder (pen not included), separator strip and elasticated band.

137 x 210 mm

SCR, DUV, HTS, TRD, TRS



A5 Corbin 93717

A5 notepad with PU hard cover. Contains 160 lined pages, bookmark ribbon available in a wide range of colours, elastic band and pen holder (not included).

140 x 210 mm

SCR, DUV, HTS, TRD, TRS



A5 Hemingway 93487

A5 notepad with 160 plain pages, PU hardcover, bookmark ribbon and elastic band.

140 x 210 mm

SCR, DUV, HTS, TRD, TRS



pocket Meyer 93425

Pocket sized notepad with 160 plain pages, hardcover in PU, bookmark ribbon and elastic band.

90 x 140 mm

SCR, DUV, HTS, TRD, TRS



Lucian
91731
📄 .89

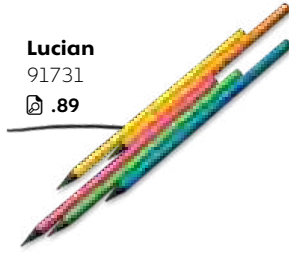

Fluorescent covers

The notepad you need to brighten up your notes.

Pages with a black border

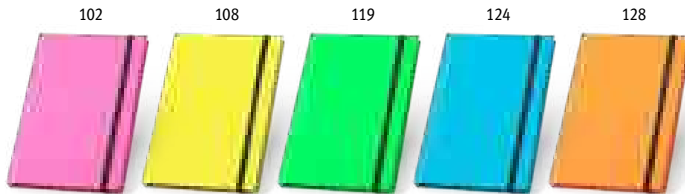

A5 Watters 93269

A5 notepad with hardcover in fluorescent PU. This notepad has 192 lined white pages with a black border, bookmark ribbon and elastic band.

📏 140 x 210 mm

🔧 LSR, DUV, HTS, SCR, TRD, TRS



Laser customisation with same colour as the elastic

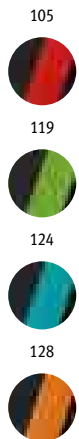

119



104

Denim fabric

A5 Roth 93592

A5 notepad with PU hardcover and 160 lined pages. Laser engraving of this notebook will match the contrasting colour of the elastic. It has a bookmark ribbon, inner pocket, and pen holder (pen not included).

📏 140 x 210 mm

🔧 LSR, DUV, HTS, SCR, TRD, TRS

A5 Denim 93594

A5 notepad with hardcover lined with denim fabric. This notepad has 192 lined pages, elastic band, bookmark ribbon, inner pocket and pen holder (pen not included).

📏 140 x 210 mm

🔧 TRS, TRD

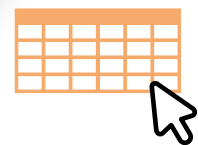

To learn more about other technical features, click here

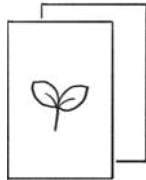

104

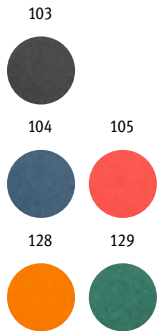

105

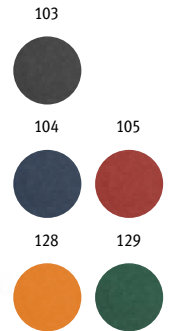

B7

Rayse 93462



Notepad B7 with 60 lined pages of recycled paper (65%) and cardboard cover.

144 x 125 mm

SCR, TRD, TRS



A5

Ecowin 93495



A5 notepad with 80 lined pages and flexible Kraft paper cover.

140 x 210 mm

SCR, TRD, TRS



160



A5

Kostova 93439



A5 notepad with 80 recycled lined pages (65%) and Kraft paper cover with inside pocket.

144 x 210 mm

TRS, SCR, TRD

With inner pocket



160



B7

Bulfinch 93461



B7 notepad with 60 plain recycled pages (65%) and Kraft paper cover.

93 x 125 mm

SCR, TRD, TRS



160



A6 Alcott A6 93274

 A6 notepad with Kraft paper cover (250 g/m²) and round corners. Contains 80 plain, sewn pages of recycled paper from sustainable forest management.

100 x 145 mm

SCR, TRD, TRS



160



A5 Alcott A5 93273

 A5 notepad with Kraft paper cover (250 g/m²) and round corners. Contains 80 plain, sewn pages of recycled paper from sustainable forest management.

140 x 210 mm

SCR, TRD, TRS



160



A4 Alcott A4 93272

 A4 notepad with Kraft paper cover (250 g/m²) and round corners. Contains 80 plain, sewn pages of recycled paper from sustainable forest management.

210 x 300 mm

SCR, TRD, TRS

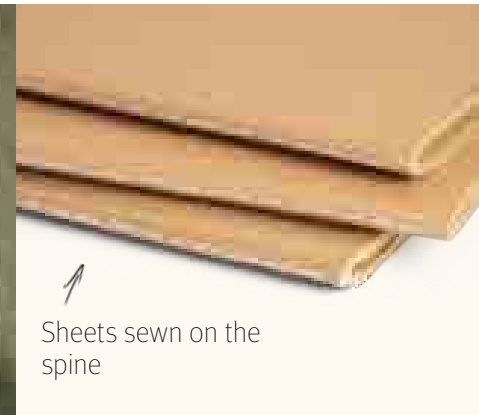

↑
Sheets sewn on the spine





160



pocket

Eliot 93792

Office set with notepad (160 recycled pages - 10%), 6 sets of sticky notes (25 sheets each), 12 cm ruler, 1 ballpoint (kraft paper), business card holder and cardboard cover with elastic band.

110 x 153 mm
PDP, DUV, SCR



103

160

notepad

Cooper 93791

Coloured sticky notepad with 6 sets (25 sheets/each) and a notepad with 100 plain pages. Pen included.

100 x 150 mm
PDP, SCR, TRD, TRS

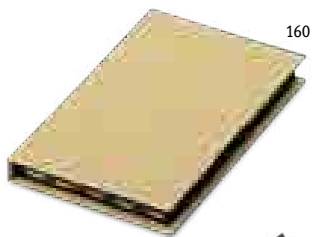

160

104

160

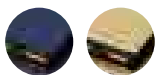

Lovecraft 93793

Sticky notes set with 12 sets (40 sheets each) and cardboard cover.

85 x 132 x 15 mm
PDP, DUV, SCR



106

103

106

160



Stooky 93421

Sticky notes set with 5 sets (20 sheets each set) and hardcover.

80 x 60 x 3 mm
PDP, SCR, TRD, TRS

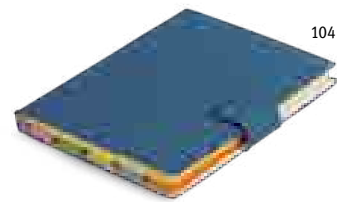

104

103

104

160



Lewis 93426

Sticky notes set with 7 sets of coloured page markers (25 sheets each set) and Kraft paper cover.

80 x 105 x 9 mm
SCR, TRD, TRS

Includes a pencil with an eraser



Bronte 93422

A7 notepad with Kraft paper hardcover, 140 plain recycled pages (60%) and elastic band. Includes a pencil with a rubber.

82 x 105 mm

SCR, DUV, PDP, TRD, TRS

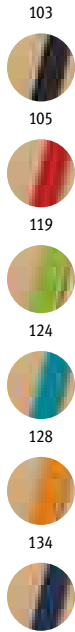

Flaubert 93709

Pocket sized notepad with 160 plain recycled pages (65%) and cardboard hardcover. This notepad has an elastic band and bookmark ribbon.

100 x 140 mm

PDP, DUV, SCR, TRD, TRS

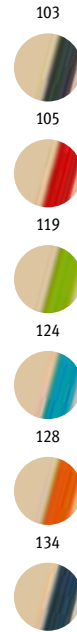

Magritte 93481

A5 notepad with 160 lined recycled paper pages (60%) and hardcover in cardboard. Contains bookmark ribbon and elastic band matching color.

137 x 210 mm

SCR, DUV, TRD, TRS

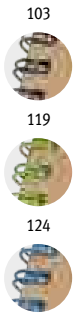

Marlowe 93707

Spiral pocket sized notepad with 120 lined recycled pages (65%), cardboard hardcover and elastic band.

100 x 140 mm

PDP, SCR, TRD, TRS



Ringord 93427

Spiral-bound pocket sized notepad with 120 plain recycled pages (60%), Kraft paper hardcover and pen holder (included).

105 x 145 mm

PDP, HTS, SCR, TRD, TRS

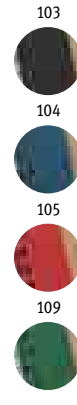

Asimov 93715

B6 spiral-bound notepad with 120 plain recycled pages (60%) and kraft hardcover. This notepad includes a pen holder and ballpoint.

130 x 177 mm

PDP, DUV, SCR, TRD, TRS



Rothfuss 93482

B6 spiral notepad with 160 lined recycled pages (60%), hardcover and pen holder (pen included).

125 x 180 mm

PDP, SCR, TRD, TRS

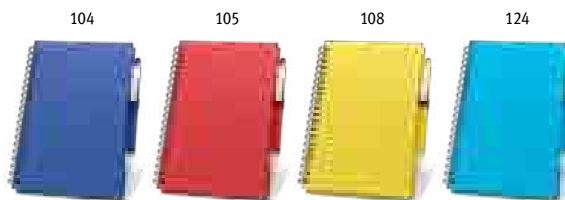

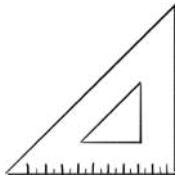

106

Stephenie 93565

Ruler with printed 15 cm scale, rounded corners and clip.

∓ 174 x 31 x 2 mm

➤ DUV, SCR

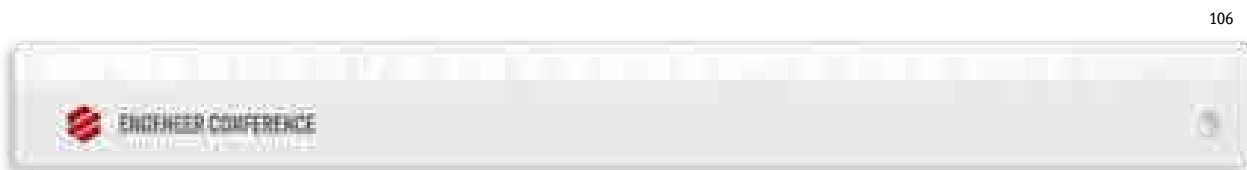

106

MADE IN EUROPE

William 93531

PS opaque ruler with a 15 cm scale in relief. Made in Europe.

∓ 163 x 25 x 3 mm

➤ SCR, DUV

MADE IN EUROPE

Frederick 93532

PS opaque ruler with a 20 cm scale in relief. Made in Europe.

∓ 211 x 28 x 2 mm

➤ SCR, DUV

MADE IN EUROPE

Becky 93533

PS opaque ruler with a 25 cm scale in relief. Made in Europe.

∓ 259 x 30 x 3 mm

➤ SCR, DUV

MADE IN EUROPE

Arthur 93553

PS opaque ruler with a 30 cm scale in relief. Made in Europe.

∓ 309 x 32 x 2 mm

➤ SCR, DUV

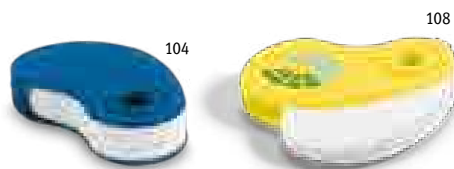

104

108

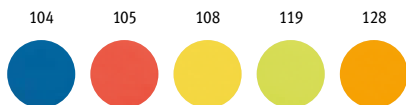

104

105

108

119

128

Siza 91935

TPR rubber with a protective PP cover.

∓ 55 x 33 x 13 mm

➤ PDP, DUV



106

Austen 91917

White TPR rubber.

∓ 55 x 22 x 12 mm

➤ SCR, DUV



103

104

105

106

Yeats 53569

Extendable badge holder. Up to 900 mm. Clear clip and button to add card or pass holder. Retractable mechanism allows the card or credential to be presented safely and comfortably.

∓ Ø32 x 9 mm

➤ PDP, DOM

WRITE

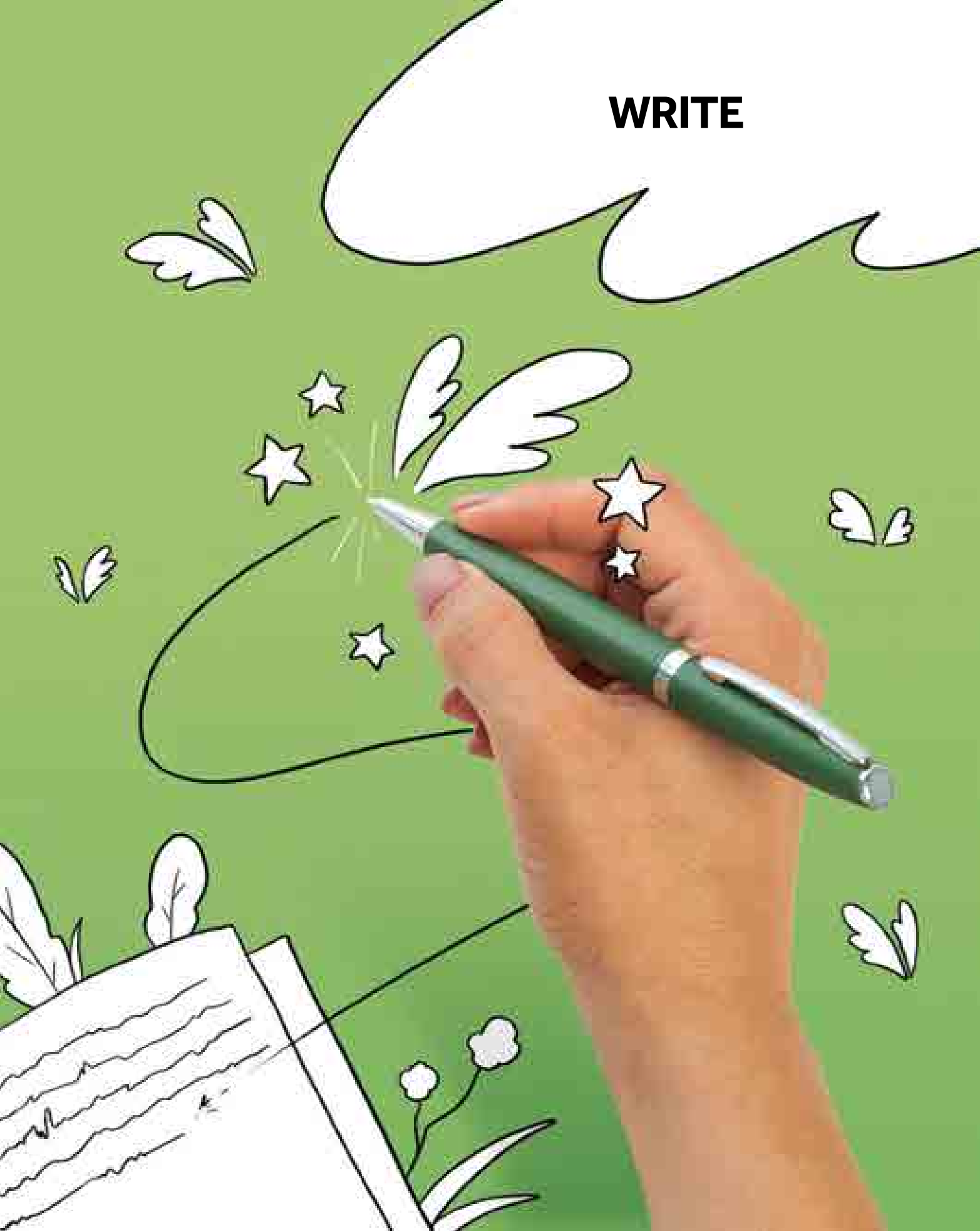



Infinity 91773

Inkless pen in bamboo with metal alloy and graphite tip. Long-lasting, erasable, with no sharpening required.

∅ 8 x 138 mm

LSR, PDP

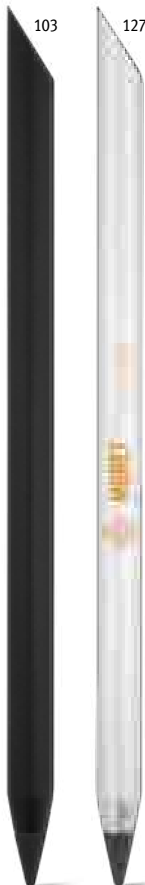

Monet 91792

Inkless aluminium ball pen with a metal alloy and graphite tip. Long-lasting with no sharpening required, you can easily erase what you write. Supplied in a gift box.

∅ 8 x 153 mm

LSR, PDP



Inkless pen

The most innovative alternative to traditional ball pens: allows erasing and has a tip with infinite writing.



Limitless 91696

Inkless pen with 100% recycled aluminium body. Suitable for long-term use without the need for sharpening. The top contains an eraser that easily erases what is written.

∅ 8 x 150 mm

PDP LSR



Stone ball pen

Composed by 45% calcium carbonate and 55% PP.



Queiros
93283
♻️ .49



Crane
93284
♻️ .49

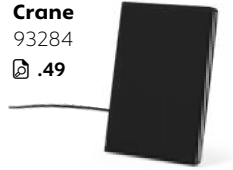

Klimt 91769

Ball pen in calcium carbonate (45%) and PP (55%). Black ink. Due to the nature of the material colour variations may occur.

♻️ Ø11 x 140 mm

♻️ PDP

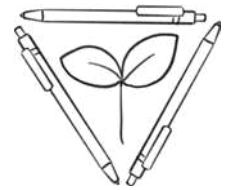

Re-Beta 91777

Ball pen in recycled aluminium (100%). Available in a wide range of colours. Blue ink.

♻️ Ø10 x 137 mm

♻️ PDP, LSR





Recycled aluminium

The recycling of aluminum reduces considerably the use of energy in the production process and avoids the emission of greenhouse gases.



Re-Lando Set 91778

 Roller and ball pen set with 100% recycled aluminium body with metal clip and tips. The sets are in the same colour and the ball pen has a twist mechanism. Blue ink.
 Supplied in a gift box.

Roller: Ø11 x 140 mm | Ball Pen: Ø11 x 140 mm
 Box: 178x46x29 mm

 **PDP**, LSR





 **Beal** 91774

Ball pen in bamboo and ABS with matte metallic finish. Features a twist mechanism and metal clip. Blue ink.

∅10 x 142 mm

LSR, PDP



 **Nicole** 81010

Bamboo ball pen with clip and metal trim. Black ink.

∅13 x 143 mm

PDP, LSR

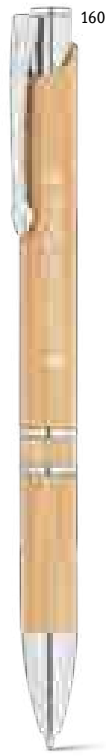

 **Beta Bamboo** 81011

Bamboo ball pen with clip and metal trim. Blue ink.

∅11 x 141 mm

PDP, LSR



 **Hera** 81163

Bamboo ball pen with metal clip. Blue ink.

∅11 x 138 mm

SRC, DUV, LSR, PDP



 **Elliot** 81009

Ball pen in bamboo with a metal clip. Blue ink.

∅11 x 137 mm

LSR, PDP



 **Zola** 91770

Bamboo ball pen with a metal clip, PP elements and matt finish. Features a touch tip in metallic grey for use with touch screens devices. Black ink.

∅11 x 141 mm

LSR, PDP



114 119 128 150



 **Kuma** 81013

Bamboo ball pen with non-slip grip and trim in wheat fibre and ABS. Blue ink.

∅11 x 142 mm

PDP, DUV, LSR



Combine the durability of bamboo with sustainable writing



160



Fuji 91775

 Ball pen in bamboo and ABS with metallic mate finishing. Features a twist mechanism and a metal clip. Black ink.

 Ball pen: Ø12 x 136 mm | Case: 25,22 mm x 165 mm

 **LSR**, PDP





160



Greeny 81162

 Bamboo ball pen and 0.7 graphite mechanical pencil set. Supplied in a Kraft paper gift box. Blue ink.

 Ø11 x 138 mm | Case: 171 x 53 x 23 mm

 **LSR**, DUV, PDP, SCR



Lake 91339

 Bamboo ball pen with twist mechanism and metal clip. Supplied with kraft paper gift pouch.

 Ø11 x 137 mm | Pouch: 155 x 40 mm

 **LSR**, PDP, SCR



160



Bahia 91820

 Bamboo ball pen with twist mechanism and metal clip. Supplied in a bamboo case. Blue ink.

 Ø11 x 140 mm | Case: 170 x 40 x 25 mm

 **LSR**, DUV, PDP, SCR

160

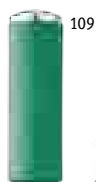

109



109 124 160

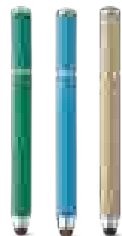

Papyrus 91621

ABS and kraft paper ball pen with touch tip. Blue ink.

∓ Ø10 x 115 mm

✓ PDP, DUV, SRC



150



Bio 91291

Wooden ball pen with transparent cap. Blue ink.

∓ Ø10 x 150 mm

✓ PDP, SRC

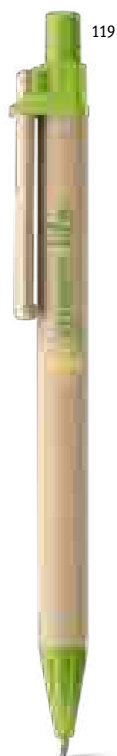

119

104 105 109 119

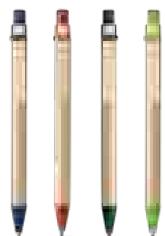

Nairobi 91292

Kraft paper ball pen with wooden clip. Black ink.

∓ Ø9 x 140 mm

✓ PDP



105

104 105 106 108 109



Remi 91628

Kraft paper ballpoint pen with clip. Available in a wide range of colors. Blue ink.

∓ Ø10 x 138 mm

✓ PDP, DUV



Enjoy the sensation of writing with a touch of elegance and respect for the environment



Natura 91647

Cork ballpoint with a metal clip.
Supplied with a Kraft paper gift pouch.

∅ 9 x 139 mm | Pouch: 155 x 40 mm

LSR, PDP, SCR



Klee 93277

∅ .46

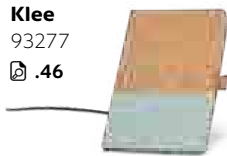

Large clip for
customisation



Goya 91795

Cork ball pen with clip and coloured
trim in wheat straw fibre and PP.
Blue ink.

∅ 11 x 140 mm

LSR, PDP



Wheatstraw fibre

The excess from the wheat grain harvest can be used to create resistant objects with less plastic in their composition.



119



Beta Wheat 91771

Ball pen in wheat straw and ABS with a metal clip and trim. Available in a wide range of colours. Blue ink.

∅10.5 x 137 mm

PDP



119

124

150



Devin 81203

Wheat straw fibre and ABS ball pen with twist mechanism and metal clip. Black ink.

∅8 x 126 mm

PDP



128

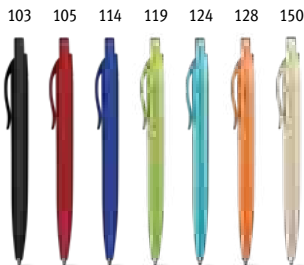

Camila 81168

Wheat straw fibre and ABS ball pen with clip, available in multiple colours. Blue ink.

∅10 x 141 mm

SRC PDP



Recycled PET

A more sustainable replacement for plastic, which helps preserve the earth's natural resources.

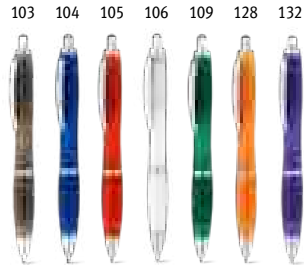

Swing rPET 91772

Ball pen in PET (100% rPET) with a metal clip. Available in a wide range of colours. Blue ink.

∅12 x 133 mm

PDP

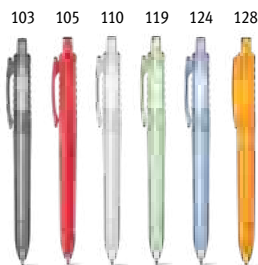

Hydra 91482

Push action ball pen in translucent PET (100% rPET) material. Blue ink.

∅11 x 139 mm



PDP

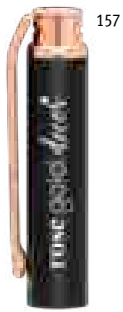



157



 **Blazon 81147**
 Metal rollerball with relief detail on barrel.
Supplied in padded gift box
∅11 x 137 mm | Case: 179 x 55 x 30 mm
LSR, LAS, PDP, SCR, TRD, TRS



103





 **Douro 91816**
 Metal pen set featuring: rollerball and ball pen with twist mechanism. Both with clips.
Supplied in a cushioned gift box. Black ink.
∅12 x 132 mm | Case: 170 x 70 x 30 mm
LSR, LAS, PDP, SCR



160



 **Cork 81401**
 Cork and metal ball pen inspired by the cork oak. Ball pen with twist mechanism and clip.
Supplied in a gift box with cork detail.
∅11 x 137 mm | Case: 180 x 56 x 30 mm
LSR



For more complete and elegant gifts

Ball pen sets and rollers are the right choice.



Carbon Fibre

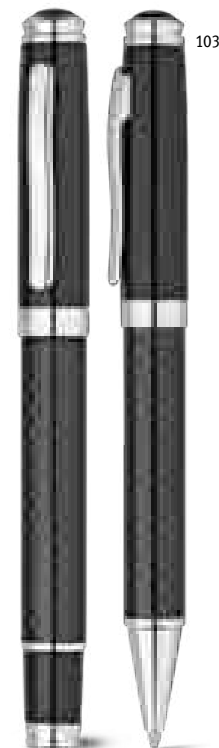

Chess 91835



Set with metal and carbon fibre rollerball and ball pen, both with a clip. Ball pen with a twist mechanism. Supplied in a cushioned PU case. Black ink.



Ball pen: Ø13 x 139 mm | Case: 195 x 100 x 47 mm

LSR, PDP, SCR



Orlando 81193



Set with metal ball pen and rollerball with clip. Supplied in a cushioned gift box with magnet closure. Blue ink.

Ball pen: Ø13 x 136 mm | Roller: Ø13 x 135 mm | Box: 192 x 34 x 85 mm

LSR, HTS, PDP



Imperio 81194



Set with metal twist action ball pen and rollerball, both with clip. Supplied in a cushioned gift box. Blue ink.



Ball pen: Ø13 x 137 mm | Roller: Ø13 x 137 mm | Box: 180 x 30 x 56 mm

LSR, PDP, SCR





Wass 81000
 Aluminium ball pen with twist mechanism, metal clip with shiny chrome plating.
 Lacquered body with glossy finish and metal refill with Dokumental® blue ink. Supplied with a self assembly gift box.

∓ Ø10 x 138 mm | Case: 175 x 41 x 20 mm
 LSR, LAS, PDP



Silverio 81170
 Metal ball pen with glossy body and clip. Blue ink. Supplied with a disassembled gift box.

∓ Ø10 x 131 mm |
 Box: 182 x 22 x 42 mm
 LSR, PDP



Montreal 91348
 Metal ball pen with twist mechanism and clip. Black ink. Supplied in a cushioned gift box.

∓ Ø11 x 138 mm |
 Case: 170 x 50 x 28 mm
 LSR, LAS



Daney 81155
 Aluminium rollerball with coloured barrel and metal clip. Black ink.

∓ Ø10 x 136 mm
 LSR, LAS, PDP



Caliope Roller 81198
 Metal roller with clip and shiny detail on the tip. Blue ink. Supplied in gift box.

∓ Ball pen: Ø10 x 136 mm |
 Box: 182 x 22 x 42 mm
 LSR, PDP



Neo 81001

Neo is an avant-garde, ergonomic aluminium ball pen with twist mechanism that is designed for professionals who use a notepad and a tablet as their office. The silicone touch tip enhances its usefulness and the matt/glossy lacquered body adds elegance. The ball pen has a metal refill with Dokumental® black ink. This product comes in a cushioned gift box.

∓ Ø10 x 138 mm | Case: 55 x 30 x 190 mm
 ↗ LSR, LAS, PDP, SRC



Stain 81208

Stain is a metal textured roller that has a lid with a Stainless steel clip. The roller Stain is inspired by geometric lines, has black Dokumental Ink® refill. It is supplied in a gift box.

∓ Ø10 x 135 mm | Box: 55 x 30 x 190 mm
 ↗ LSR, PDP

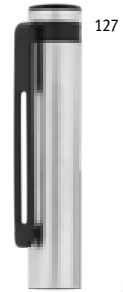

Ezekiel 81195

Metal ball pen with twist mechanism, clip and golden trim. Blue ink. Supplied in a kraft paper case.

∓ Ø11 x 139 mm | Box: 180 x 43 x 22 mm
 ↗ LSR, PDP, SCR



Ezekiel Roller 81196

Metal roller with gold trim. Blue ink. Supplied in a kraft paper case

∓ Ø11 x 140 mm | Box: 180 x 43 x 22 mm
 ↗ LSR, PDP, SCR





Convex 91495
 Ball pen in aluminium and ABS with a clip.
 Blue ink.
 ∅11 x 145 mm
 LSR, PDP, SRC

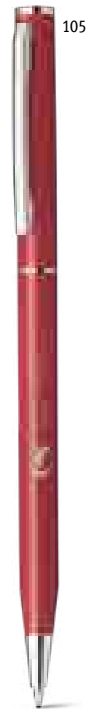

Lesley Metallic 81185
 Metal ball pen with clip. Blue ink.
 ∅7 x 129 mm
 LSR, PDP



Lapoint 81201
 Multifunction metal ball pen with clip. Ball pen with mini LED torch, laser pointer and touch tip. Supplied in a metal case. Includes 3 LR41 batteries. Blue ink.
 LED ∅10 x 125 mm | Box: 178 x 38 x 19 mm
 LSR, DOM, PDP, SCR



Touch 51437
 Rollerball in metal with laquered gloss finish and chrome detail. The stylus touch tip makes this sophisticated gift adaptable to new technologies. Black ink. Supplied with a self assembly gift box.
 ∅9 x 141 mm | Case: 150 x 15 x 19 mm
 LSR, LAS, PDP, SCR



119 124 127 137 147



 **Lea 81125**

Aluminium ball pen with clip and matte finish. Blue ink.

∅10 x 137 mm

LSR, LAS, PDP



103 106 112 137 167



 **Clare 81156**

Aluminium twist action ball pen with clip. Available in four stylish colours. Black ink

∅10 x 140 mm

LSR, PDP



106 112 127 137 147 167

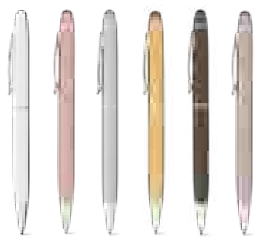

 **Julie 81144**

Metal ball pen with stylus tip. Supplied with a self assembly gift box. Blue ink.

∅10 x 141 mm | Case: 150 x 15 x 19 mm

LSR, PDP, SCR





117



Joan 91694

Colour laser effect
Choose the colour and match it with
laser engraving.

∅10 x 140 mm

LAS, LSR, PDP



Colour laser effect

Engrave and combine your creativity
with the colour of the button! Details
that add value to your brand!



113

Gel refills

For a smoother and more
fluid writing.



Bolt 81134

ABS ball pen with rubber finish, metal clip and
anti slip grip. Black ink. Gel refill included.

∅12 x 140 mm

PDP, DUV



Rubber finish



 **Marieta Soft 81189**
Aluminium ball pen with rubber finish and clip. Blue ink.
∅11 x 139 mm
LSR, DUV



 **Poppins 81140**
Aluminium ball pen with coloured body and rubber finish. Blue ink.
∅10 x 137 mm
LSR, DUV

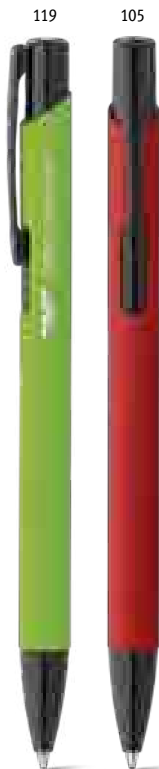

 **Olaf Soft 81192**
Aluminium ball pen with rubber finish and clip. Blue ink.
∅10 x 137 mm
LSR, DUV



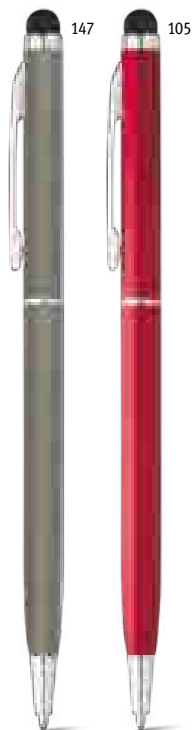

Zoe 91624
 Aluminium ball pen with twist mechanism, clip and touch tip. Blue ink.
 ∅ 8 x 135 mm
 SRC, LSR, PDP

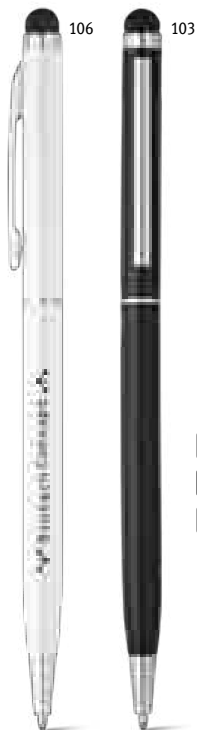

Zoe Bk 81158
 Aluminium ball pen with twist mechanism and clip. Black ink.
 ∅ 8 x 135 mm
 SRC, LSR, PDP



Antibacterial
 treatment
ISO 22196

Beta Safe 81213
 ABS ballpoint with antibacterial treatment, according to ISO 22196 certification, with metal clip and trim. Blue ink.
 ∅ 11 x 140 mm
 PDP, DUV







 **Galba** 91849
 Aluminium ball pen with touch tip and clip. Blue ink.
 ∓ ∅8 x 142 mm
 LAS LSR, PDP

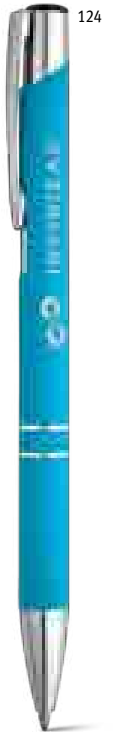

 **Beta Soft** 81141
 Aluminium ball pen with coloured body and rubber finish. Black ink.
 ∓ ∅10 x 137 mm
 LAS DUV, LSR



 **Beta Bk** 81165
 Aluminium ball pen with clip and shiny body, available in various colours. Black ink.
 ∓ ∅10 x 137 mm
 LAS LSR, PDP



 **Beta** 91311
 Aluminium ball pen with clip and metallic finish. Blue ink.
 ∓ ∅10 x 137 mm
 LAS LSR, PDP

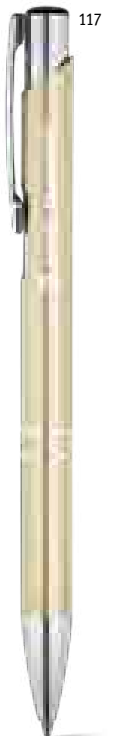





127

103 105 114 127







Mobile phone holder

-  **Tecna 91642**
-  Ball pen with metallic finish, touch tip and mobile phone support. Black ink.
-  $\varnothing 11 \times 144 \text{ mm}$
-  **PDP**, DUV



103 114 127



-  **Esla 91699**
-  Ball pen with metallic finish, metal clip, twist mechanism and touch tip. Black ink.
-  $\varnothing 10 \times 145 \text{ mm}$
-  **SRC**, PDP







109

4 colours in 1



103 104 105 109



-  **Octus 81175**
-  4 in 1 ball pen with non-slip grip, with blue, red, green and black ink.
-  $\varnothing 13 \times 138 \text{ mm}$
-  **PDP**, DUV

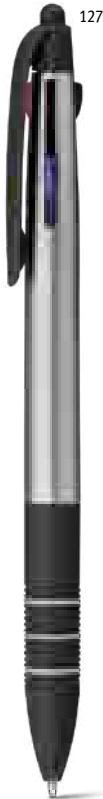





127

3 colours in 1

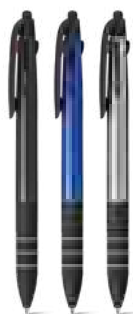

103 114 127



-  **Multis 81179**
-  3 in 1 multi colour ball pen with non-slip grip and stylus tip. Blue, red and black ink.
-  $\varnothing 10 \times 148 \text{ mm}$
-  **PDP**, DUV

103 104 109 115 138



Elbe 91671

Ball pen with twist mechanism, metal clip and metallic finish. Blue ink.

∅10 x 140 mm

PDP, SRC



103 105 106 114 127



Lena 91600

Ball pen with twist mechanism and metal clip. Blue ink.

∅10 x 142 mm

PDP, DUV



103 104 105 106 109 123 124 127 128 132



Beta Plastic 81182

Ball pen with metal clip, available in various colours. Blue ink.

∅10 x 138 mm

PDP, DUV



103 105 106 114 122



Aroma 81133

Twist action ABS ball pen with clip and metallic finish. Black ink.

∅11 x 146 mm

PDP, DUV





 **Straced** 91625
Ball pen with clip. Blue ink.
∅11 x 140 mm
SRC, DUV, PDP

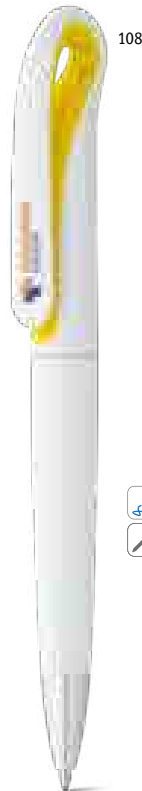

108



 **Toucan** 91396
Ball pen with twist mechanism and clip.
Blue ink.
∅13 x 147 mm
PDP, DUV



 **Boop** 81129
Ball pen with clip and twist mechanism.
Available in several colours. Blue ink.
∅11 x 147 mm
PDP



119 102



 **Caribe** 91256
ABS ball pen with non-slip grip and clip.
Blue ink.
∅10 x 138 mm
PDP, DUV

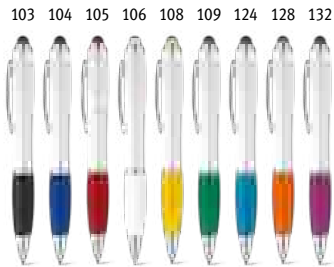

Sans 91634

Ball pen with metal clip and twist mechanism. Suitable for use on devices due to its touch tip and comfortable non-slip grip, available in several colours. Blue ink.

∅11 x 135 mm

PDP, DUV

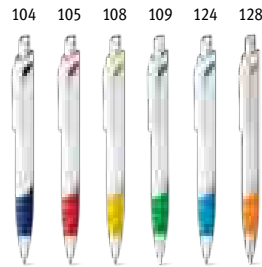

Molla 81174

Ball pen with clip and coloured non-slip grip. Blue ink.

∅13 x 140 mm

PDP, DUV

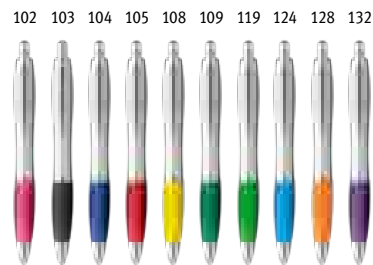

Swing 91019

Ball pen with metal clip and coloured non-slip grip. Blue ink.

∅12 x 140 mm

PDP, DUV

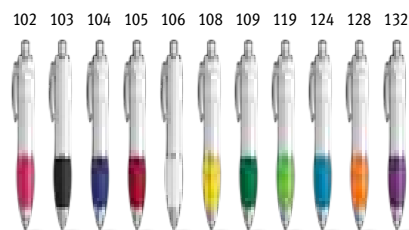
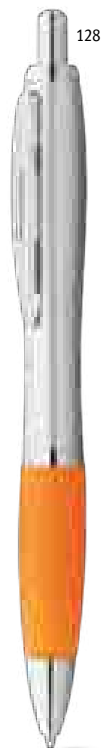

Move 81132

Colours available: 102, 103, 104, 105, 106, 108, 109, 119, 124, 128, 132

Move Bk 81161

Colours available: 102, 104, 105, 106, 108, 109, 119, 124, 132

Push action ball pen with white barrel, coloured non-slip grip and chrome trim. Black ink.

∅12 x 140 mm

PDP, DUV



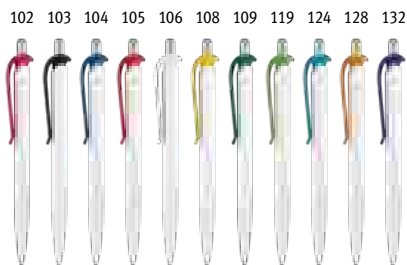

 **Ana** 91693
ABS ball pen with clip. Blue ink.
∅ 10 x 145 mm
PDP, DUV

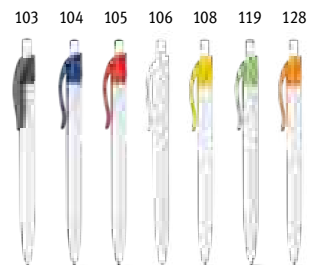

 **Mars** 91498
Ball pen with coloured clip. Black ink.
∅ 10 x 140 mm
PDP, DUV

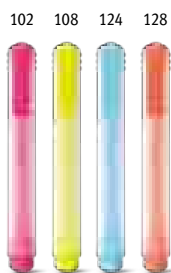
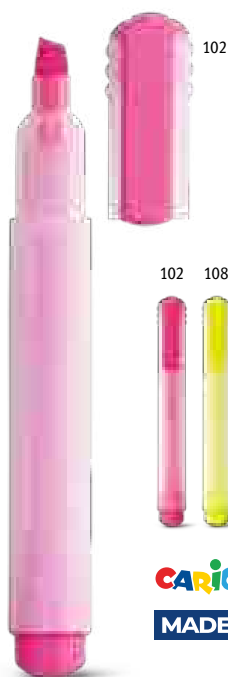

CARIOCA
MADE IN EUROPE

Memory Flash 91604

CARIOCA® highlighter with clip and non-slip relief at the tip. Clear body and cap.

15 x 123 mm
PDP



Spark 91613

Highlighter with clear body and cap.

26 x 104 mm
PDP, DUV



Trian 91615

3-colour triangle shaped highlighter: yellow, pink and green.

79 x 79 x 13 mm
PDP, DUV, SCR

103 105 108 109 114 128



 **Lucy 81136**

PP ball pen with coloured tip and transparent lid. Blue ink.

∅10 x 142 mm
PDP, DUV, SRC



CARIOCA

MADE IN EUROPE

 **Corvina Bk 81169**

CARIOCA® ball pen with cap with clip. Black ink. Made in Europe.

∅10 x 145 mm
SRC, DUV, PDP

103



103 104 105 106 108 109 124 128



128



CARIOCA

MADE IN EUROPE

 **Corvina 91216**

CARIOCA® ball pen with coloured cap with clip. Blue ink. Made in Europe.

∅10 x 145 mm
SRC, DUV, PDP

103



 **Slope 81150**

Ball pen with ABS holder. Includes base sticker to attach to smooth surfaces. Extendable pen chain.

90 x 140 x 102 mm | Ball pen: ∅9 x 139 mm
PDP

103 104 105 106 108 109 112 119 124 128 132



108



 **Slim Bk 81160**

 **Slim 91247**

Ball pen with clip and coloured non-slip grip. Blue ink.

∅10 x 145 mm
PDP, DUV



160

Rhombus 91932

Writing set that includes a 16.5 cm ruler, 2 graphite pencils (HB), 1 rubber and 1 sharpener. Set supplied in a Kraft paper case.

📏 Pouch: 190 x 45 x 20 mm

🔪 LSR, PDP, SCR



127

Brentano 91737

Set with two sharpened pencils supplied in Kraft paper case.

📏 Pouch: 190 x 40 x 12 mm

🔪 PDP, SCR



106

Austen 91917

White TPR rubber.

📏 55 x 22 x 12 mm

🔪 SCR, DUV



108



119

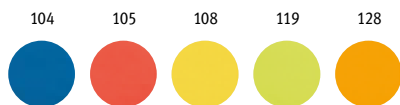

Siza 91935

TPR rubber with a protective PP cover.

📏 55 x 33 x 13 mm

🔪 PDP, DUV



150

Grafit 91768

Wooden carpenter's pencil (not sharpened).

📏 11 x 175 x 7 mm

🔪 PDP, DUV, LSR



104



106

Grafit Colour 91725

Wooden carpenter's pencil (not sharpened).

📏 11 x 175 x 7 mm

🔪 PDP, DUV



Mini pencil



Barter 91759

Mini graphite pencil with rubber. Degree of hardness: HB.

∅7 x 100 mm

➤ PDP, LSR



Cornwell 91716

Sharpened graphite pencil with rubber. Degree of hardness: HB.

∅7 x 190 mm

➤ PDP, DUV, LSR



Ernster 91721

Sharpened graphite pencil with rubber. Degree of hardness: HB.

∅7 x 190 mm

➤ PDP, DUV, LSR

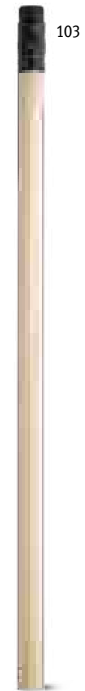

Pollock 91722

Natural wood pencil with black top and rubber. Not sharp. Degree of hardness: HB.

∅7 x 190 mm

➤ PDP, DUV, LSR



Ateneo 91736

Graphite pencil with coloured body and rubber (not sharpened). Degree of hardness: HB.

∅7 x 190 mm

➤ PDP, DUV

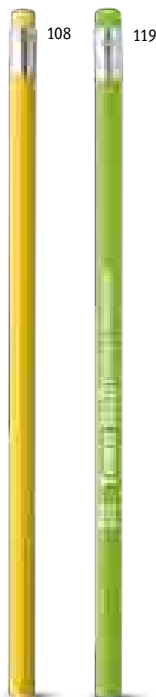

Lucian 91731

Wooden neon color pencil (Not sharp). Degree of hardness: HB.

∅7 x 175 mm

➤ PDP, DUV

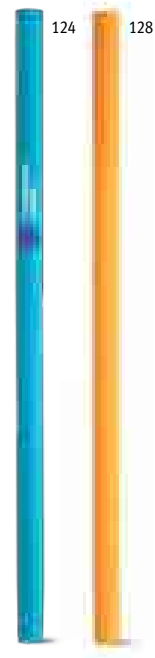

Make your offer even more special

Reinforce the connection with your brand and show all your dedication by completing your offer with our cases.

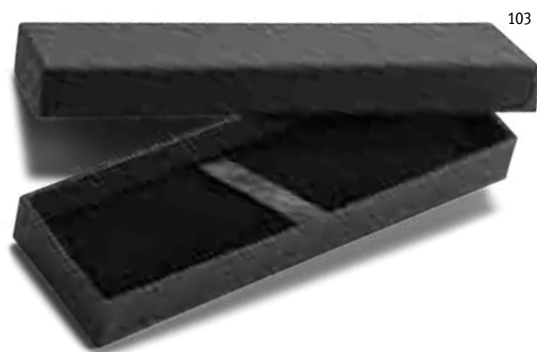

Casie 91955

Kraft paper case for 1 ball pen. Interior with elegant velvet cushion.

± 175 x 55 x 25 mm

TRS, TRD



Pendolo 91970

Kraft paper case for 1 ball pen.

± 180 x 43 x 22 mm

SCR, DUV



Adolia 13212

Gift case for 2 ball pens.

± 174 x 22 x 46 mm

PDP



Lello 91973

Kraft paper pouch for 1 ball pen. Supplied flat packed.

± 150 x 15 x 19 mm

PDP, HTS, SCR

BAGS



EUROPEAN DESIGN

THE BRAND THAT MATCHES

Know more online

branve.com

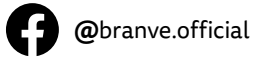

All BRANVE® products have the best certifications, as a guarantee of quality

EMPIRE COLLECTION

Exclusive for sophisticated personalities

Maintain identity in a world that requires organization and focus. Determined to differentiate executive life, Empire is sophisticated, modern but attentive to detail. In this empire, functionality and personality are marked by the carefully chosen materials where each element has an inherent purpose – the shape adapts to function. Who said that organization couldn't be elegant?

Empire Notebook
93598
📄 .53

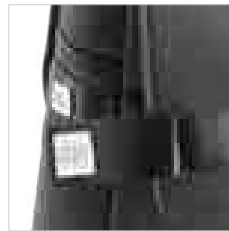

Innovative closure system



Durable and resistant base



quality tests report

103

Empire Backpack 92680



The Empire is a city sophisticated imitation leather with PU backpack. Its flap hides the front pocket and main compartment. The main compartment also closes with a zipper and its interior is made of 2 padded dividers, compatible with a laptop up to 14" and a tablet up to 10.5", and several pockets for easy storage. The side zippers have sturdy magnets and metal plates ideal for customisation. The back with padded backrest and fully padded straps ensure maximum comfort and the reinforced bottom corners ensure durability. Interior pockets. Metallic closure. The EMPIRE backpack has a trolley carrying strap, which makes it a versatile and practical object for both everyday and business trips. Supplied in a non-woven bag. Capacity up to 9 L. Product includes Quality Test Report.

📏 Backpack: 290 x 370 x 90 mm | Bag: 500 x 500 x 80 mm
🏭 LSR, SCR

Find other BRANVE® products

📄 .75 Write



Durable and resistant base

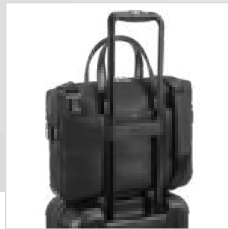

Trolley socket



Durable and resistant base

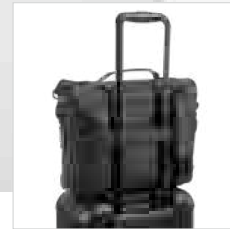

Trolley socket



quality tests report

103

Empire Suitcase II 92359

The Empire II is a classic and sophisticated high quality textured polyfleece briefcase. It has 2 outer pockets with hidden zippers, and several inner pockets in the front, that facilitate storage. The main compartment closes with a zipper and contains 2 padded dividers, compatible with a laptop up to 15.6" and a tablet up to 10". The finest detail was taken into account during its design, like all the products in this collection. This makes the Empire II briefcase the ideal ally for everyday life, which doesn't go unnoticed. The trolley strap adds versatility when travelling. The briefcase is supplied in a non-woven bag. Product includes Quality Test Report.

✚ EMPIRE SUITCASE II: 380 x 280 x 80 mm | Bag: 500 x 500 x 80 mm
✚ SCR, LSR



quality tests report

103

Empire Suitcase I 92360

Empire I is a modern executive high quality PU briefcase with a touch of sophistication. It has 2 hidden external pockets and a main compartment that closes with a flap. The main compartment contains 2 padded dividers, compatible with a laptop up to 14" and a tablet up to 10.5", and several pockets that facilitate storage. The different ways of transporting this briefcase make it a versatile bag, which is reinforced by its trolley strap. The innovative Empire I magnet closure on the side makes this briefcase unique. The design details focus on both functionality demonstrated by the metallic details on the handle guaranteeing the quality and uniqueness of the Empire I. The briefcase is supplied in a non-woven bag. Product includes Quality Test Report.

✚ EMPIRE SUITCASE I: 370 x 270 x 80 mm | Bag: 500 x 500 x 80 mm
✚ LSR, SCR

ROVER COLLECTION



Waterproof



quality tests report

103



Rover Backpack 92146

Versatile backpack adaptable to any look due to its modern and light material: microfibre. Ideal to carry your personal belongings during a walk or when travelling. Furthermore, it can be used in two sizes: with the top folded or open. The bottom in imitation leather allows it to be cleaned easily. It also comes with a detachable pouch with a main compartment and a front pocket, with detachable webbing that allows the use in different ways on the shoulder, in the waist and crossbody, perfect for a busy daily life and to carry the essentials. Capacity up to 12 L. Supplied in a non-woven bag. Product includes Quality Test Report.

± Open: 300 x 415 x 110 mm |
Closed: 300 x 330 x 110 mm | Pouch: 225 x 135 x 20 mm |
Non-woven bag: 500 x 500 x 80 mm

LSR

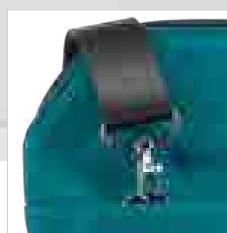

Adjustable straps

Possibility of folding the top



quality tests report

174



Rover Backpack II 92188

The Rover Backpack II is a versatile backpack adaptable to any look and the ideal choice for a walk or a trip, due to its modern, light and practical fabric. The details in PU, as well as the small metal accessories, make it an elegant and attractive product. The PU bottom allows it to be cleaned easily. The backpack has two external pockets and a main compartment, with an inner pocket. The back and the front are the same, only in different colours, black or blue, and with detachable straps, it can be worn on both sides. This backpack can be used in two sizes: folded top or open top and in different shapes: backpack or shoulder bag, perfect for a busy everyday life and to carry the essentials. Capacity up to 12L. Supplied in a non-woven bag. Product includes Quality Test Report.

± Fully open backpack: 300 x 420 x 110 mm |
Partially closed backpack: 300 x 330 x 110 mm |
Non-woven bag: 500 x 500 x 80 mm

TRS, TRD

DIVERGENT COLLECTION

The shape that fits any style

To be Divergent is to be bold but practical. A line that adapts to your essence and style, allowing you to stand out anywhere.



Hidden pocket for added security

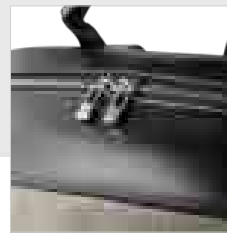

High quality closures



134

Divergent Backpack I 92189



Backpack with a mix of contemporary materials, with a young and irreverent touch that results from the contrast of denim with the elegance of black and irregular texture from PU. Its high quality zipper, with rubber finishing, along with the top in PU, gives the backpack some water resistance. The PU bottom allows it to be easily cleaned. Interior compartment with elegant design and details in PU, contains a padded pocket for computer up to 15.6" and two pockets with zippers. One of the pockets is made of elastic material, giving it a greater storage possibility. The adjustable side strips, aesthetics, can serve as support for placing elements, such as hanging a jacket or as support for a headset cord. Padded straps and handle with hand reinforcement for comfort, a rear anti-theft pocket and a hidden front pocket. Also includes a trolley strap. Capacity up to 15 L. Supplied in a non-woven bag. Product includes Quality Test Report.

📏 Backpack: 320 x 430 x 125 mm | Non-woven bag: 500 x 550 x 130 mm

🔧 LSR, TRD, TRS



131

Divergent Backpack II 92147



Backpack with a mix of contemporary and irreverent materials, with a touch of elegance coming from the two tones of its fabric and the contrast with the black in PU. The accessories and the high quality metal zipper, reinforce its elegance and give shine to the product. Interior compartment with elegant design and details in PU, contains a padded pocket for computer up to 15.6" and two pockets with zippers. One of the pockets is made of elastic material, giving it a greater storage possibility. The adjustable side strips, aesthetics, can serve as support to place objects, such as hanging a jacket or as support for a headset cord. Padded straps and handle with hand reinforcement for comfort, a rear anti-theft pocket and a hidden front pocket. Also includes a trolley strap. Capacity up to 14 L. Supplied in a non-woven bag. Product includes Quality Test Report.

📏 Backpack: 320 x 430 x 125 mm | Non-woven bag: 500 x 550 x 130 mm

🔧 TRS, TRD

DYNAMIC COLLECTION

For the dynamic with more style

Business and leisure can go hand in hand. It is important to maintain the frenetic cosmopolitan rhythm and the secret is multifunctionality. Being versatile means knowing how to combine the unlikely – robustness and harmony, practicality and nobility of materials. With Dynamic, objects multiply but they are simultaneously one: it is energy in movement.

Dynamic Notebook 93597

 .53



2 in 1 backpack



Compartments for laptop, tablet
and other objects



104

Dynamic Backpack I 92682

DYNAMIC 2 in 1 is an urban backpack that is distinguished by its versatility and duality. Its efficient design allows it to be a unique and versatile object that divides discreetly into a backpack and a travel bag. The 1680D material gives the backpack robustness and the imitation leather details give it a city and modern look. The backpack is composed of a front pocket with hidden closure, a rear anti-theft pocket and a main compartment with two padded pockets inside, which allow you to protect your laptop up to 15.6" and tablet up to 10.5". The DYNAMIC 2 in 1 has a trolley band that underlines its practical and functional side. The two parts of this backpack can be used separately or as a single piece. Supplied in a non-woven bag. Capacity up to 22 L. Product includes Quality Test Report.

300 x 420 x 200 mm |
Backpack: 300 x 420 x 75 mm | Travel bag: 300 x 420 x 130 mm |
Bag: 550 x 580 x 210 mm
LSR, SCR



2 in 1 backpack



Laptop and tablet compartment



104

Dynamic Backpack II 92187

Versatile 2-in-1 backpack, contains two parts: backpack + cooler. Defined by its functionality and ease of transport thanks to the two parts with different functions in a single product. Ideal for everyday use to carry your meal together with your work objects. Besides this, the two parts can be used separately, which makes it even more versatile. The backpack is mostly composed of 1680D polyester and nylon, a tough and durable material. The contrasting PU details, two textures and two colours, break up the robustness of the main material, giving it a subtle, city look. Dual interior design, with two padded interior pockets for 14" laptop and 10.5" tablet, and organiser strip for cables and pens. The cooler has PEVA interior and waterproof zipper to maintain the temperature. The anti-theft pocket on the back and the front pocket with hidden zipper make it perfect for walking around town. Also includes a trolley strap for easy travelling. Supplied in non-woven bag. Capacity up to 20 L. Supplied in a non-woven bag. Product includes Quality Test Report.

⊞ Backpack: 300x380x150mm | Thermal Bag: 300x120x150mm | Set: 300x500x150mm | Non-woven bag: 550 x 580 x 210 mm

LSR



DIVERSITY COLLECTION

The line that fits urban diversity

The Urban routine requires flexibility. While assuming an alternative and bold style, the Urban line is prepared for all the daily incidents, facing them with enthusiasm, lightness and the right dose of sobriety. Trendy items for those who are always ready for change.

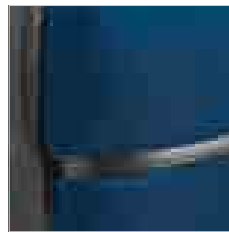

Waterproof material and protective closures



**Urban Backpack
92683**

104 133



The URBAN is a versatile, high-density soft shell city tarpaulin backpack. Designed to hold a laptop up to 14" and 10.5" tablet. The URBAN's waterproofness makes it a unique object. The impermeability comes both in its fabric and in the design of the zippers that protect the inside of the backpack. The front pocket is spacious and the access to it is very intuitive. The adjustable straps and hand grip contribute to the versatility of the backpack. URBAN is supplied in a non-woven bag. Capacity up to 7 L. Product includes Quality Test Report.

⊞ Backpack: 400 x 300 x 70 mm |

⊞ Bag: 500 x 500 x 80 mm

⚡ TRS, TRD

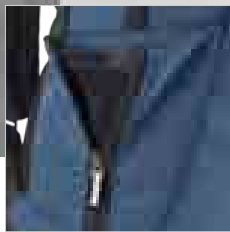

Extra pocket

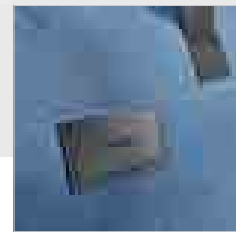
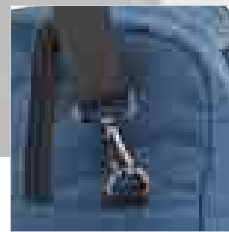

Adjustable straps



quality tests report

104 123



Motion Backpack
92681

MOTION BACKPACK is a backpack with an irreverent and unique design in 600D and high quality imitation leather. The backpack has several compartments, pockets inside and two padded pockets designed specifically to protect a laptop up to 15.6" and a tablet up to 10.5". The straps and padded back accentuate the comfort of this backpack. The trolley strap is another feature that emphasizes the practical side of this backpack, facilitating its transport. The front pocket with flap and the side pockets are also unique in their design, from the asymmetry of the front pocket to the discreet pocket on the side that allows you to store a bottle of water. The backpack is supplied in a non-woven bag. Capacity up to 18 L. Supplied in a non-woven bag. Product includes Quality Test Report.

⌄ Motion Backpack: 410 x 330 x 150 mm | Bag: 500 x 500 x 80 mm
 ⚡ LSR, SCR, TRD, TRS



quality tests report

104 123



Motion Bag
92521

The Motion Bag is a practical and stylish 600D cationic polyester travel bag with split leather with PU. Its spacious main compartment is ideal for storing clothes and other utilities needed for short trips. It also has four inside pockets and a front pocket with an asymmetrical design flap, which characterizes this line and gives it a modern look. The practicality of this bag is matched by a detailed and careful design that leads to details such as the space to put the name tag, the metallic feet that protect the bag when set down, the design of the zipper that allows it to be closed with a lock (not included) and the straps designed to be adjustable and comfortable. Motion Bag is supplied in a non-woven bag. Capacity up to 32 L. Supplied in a non-woven bag. Product includes Quality Test Report.

⌄ Motion Bag: 500 x 300 x 250 mm | Bag: 700 x 450 x 75 mm
 ⚡ SCR, LSR, TRD, TRS

A selection of backpacks that provide the security you need to carry your personal computer



Business 92098

15.6" Laptop and tablet backpack in 300D PET (100% rPET) and 210D PET (100% rPET). Features a padded main compartment with a built-in divider for laptops and tablets up to 10.1", 2 zipped front pockets, 2 mesh side pockets and adjustable padded back and shoulder straps. The backpack incorporates a trolley strap and is an ideal design providing excellent storage for your work or leisure trips. Capacity up to 18 litres.

300 x 450 x 140 mm

TRD TRS



Federer
94272
📄 .165



103



104



129

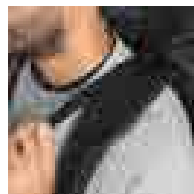

Alasca 92092

Hiking-style backpack for everyday use in urban environments, adventures or outdoor sports. The functional design combined with the quality and resistance of the materials make this backpack a unique product. Made from 600D PET (100% rPET) with a waterproof coating. The backpack consists of 1 main compartment with a multifunction pocket in 210D PET (100% rPET), 1 separate fully padded compartment for a laptop up to 14" and mesh side pockets. The top pocket has a zip fastener. This backpack has special features such as multifunctional belt loops, weight control straps, chest strap. Capacity up to 18 litres.

📏 280 x 455 x 160 mm

🏠 TRD TRS



Delfos Backpack 92192

300D PET (100% rPET) and 600D PET (100% rPET) laptop backpack with reflective elements. It has 1 main compartment with 1 multifunctional pocket and a pocket for a laptop up to 15.6". It contains 1 front pocket with zipper, 2 side mesh pockets and an elastics on the front to carry different objects. The handles and the back are padded. Capacity up to 18 L.

320 x 450 x 140 mm

TRS, EDB, ETD, TRD



Delfos 92191

300D PET (100% rPET) and 600D PET (100% rPET) single strap backpack. It has a main compartment and front pocket with zipper. Contains reflective elements and an inner elastic band to carry a bottle. The straps and the back are padded.

200 x 340 x 80 mm

TRS, TRD



Delfos Pouch 92091

300D PET (100% rPET) and 600D PET (100% rPET) waist bag with reflective elements. Contains 1 main compartment with double zipper and 1 front pocket to carry a bottle. The strap is adjustable.

270 x 120 x 70 mm

TRS, EDB, ETD, TRD

Resistant rPET backpacks



The functional design combined with the quality and strength of the materials make these backpacks unique.



Repurpose Backpack 92080

600D PET (100% rPET) computer backpack with padded shoulder straps. The main compartment has 2 padded dividers for computer up to 15.6" and tablet up to 10.5". Contains two front zipper pockets and one side elastic mesh pocket. Padded back with trolley band. Capacity up to 12 L.

300 x 420 x 110 mm

TRS EDB, ETD, TRD



Repurpose Cooler 98427



600D PET (100% rPET) cooler with PEVA interior. Adjustable webbing shoulder strap, front pocket and double way zipper. Capacity up to 7 L.

240 x 170 x 170 mm

TRS TRD



7 L

Repurpose Bag 92078

92078

.239



Repurpose Sports 92079

600D PET (100% rPET) sports bag with inner lining and semirigid board on the bottom. Main compartment and frontal pocket with zipper and two side pockets, one in mesh and the other with zipper. The bag has detachable and adjustable webbing padded shoulder strap and handles with reinforcement. Capacity up to 31 L.

500 x 300 x 230 mm

TRS EDB, ETD, TRD



31 L

Removable plate with magnet

21 L



133

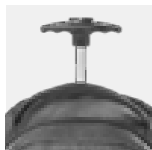

15,6"

Eindhoven 92145

Laptop trolley backpack in high density 600D and waterproof 600D polyester. Main compartment for laptop up to 15.6". Contains mesh side pockets and a double zipped front pocket. Trolley backpack with wheel protector and extendable metal handle. The back and handles are padded. Includes a removable magnetic metal plate for easy customization. Capacity up to 21 L.

340 x 430 x 170 mm | Plate: 50 x 20 mm

LSR, TRD, TRS

Removable plate with magnet

28 L



103

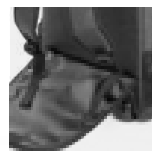

17"

Avenir 92177

Laptop trolley backpack in 1680D and 300D. It's main compartment is padded and cushioned has a divider for a laptop up to 17". It contains 2 front pockets and 2 zippered side pockets. This trolley has a wheel protector, padded handles, extendable metal spring grip and includes a removable magnetic metal plate for easy customization. It has capacity up to 28 L and weighs 1.80 kg. Metal plate customisable with laser supplied seperately.

330 x 490 x 220 mm | Plate: 50 x 20 mm

LSR, DOM, TRD, TRS

28 L



105

123



Puebla 92115

Travel Trolley in 600D and EVA with semi-rigid front compartment and lined interior. Identification tag on the back. Extendable aluminium handle with spring. The trolley has a capacity up to 28 L and weighs 2.95 kg.

345 x 520 x 195 mm

TRS, TRD



15,6"

Alexandria 92329

300D hybrid backpack (2 in 1) with 2 carrying modes. It has backpack mode, with a back and padded straps with a mechanism that allows you to hide them. It can also be used in briefcase mode, with a reinforced and comfortable hand grip. It has 2 main compartments: 1 with a laptop pocket up to 15.6" and another with several multifunctional pockets. It also has 1 front pocket with a zipper and a carrying strap for the trolley. Capacity up to 14 L.

320 x 425 x 120 mm

TR5 TRD

Waterproof backpack



15,6"

15,6"

10,5"

Osasco 92637

Waterproof 600D polyester laptop backpack with waterproof zippers. Padded main compartment for laptop up to 15.6". Contains a side pocket and a front pocket. Padded back and straps, with padded support system for the back. Capacity up to 10 L.

245 x 400 x 115 mm

TXP TRD, TR5



Bologna 92999

300D laptop backpack with 1 main compartment with 2 lined pockets for a laptop up to 15.6" and a tablet up to 10.5" and several interior pockets. It also contains 1 front pocket and 1 side pocket. Includes carrying strap for trolley and the back and handles are padded. Capacity up to 14 L.

320 x 410 x 120 mm

TR5 EDB, ETD, TRD



103



Zippers Backpack 92280

840D jacquard and 300D laptop backpack with 2 compartments. The back compartment is lined and padded, with 2 padded computer compartments up to 15.6" and 10.5" tablet. The front compartment is lined and has several interior pockets. It has 3 front pockets and 2 side pockets. The back is padded, has padded back support and padded straps. Capacity up to 25 L.

± 320 x 450 x 190 mm

➤ TRS, TRD



103



Angle Backpack 92270

Laptop backpack in PU and 1680D. Compartment with padded partition for laptop up to 15.6". Lined and padded interior. It contains several interior pockets. The backpack has 2 front pockets and a customizable board. Padded straps and back with padded support system for the back. Capacity up to 17 L.

± 340 x 450 x 130 mm | Plate: 40 x 20 mm

➤ LSR, TRD, TRS



30 L

103

Zippers Sport 92516

Executive sports bag in 840D jacquard and 300D and lined interior. Contains front pockets, bottom with semi-rigid board, adjustable shoulder strap with padded reinforcement. Capacity up to 30 L.

± 520 x 300 x 220 mm

➤ TRS, TRD





Boston 92675

Waterproof 2Tone Nylon laptop backpack with 2 compartments. Lined rear compartment with interior zipped pocket and padded partition for laptop up to 17". Lined front compartment with several interior pockets. The backpack has 2 front pockets and 2 side pockets. USB port and USB/micro USB cable to connect to mobile devices. Padded straps and back with padded support system for the back. Accessories not included. Capacity up to 26 L.

310 x 470 x 200 mm

TR5, TRD

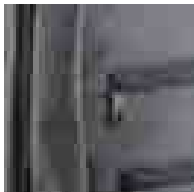
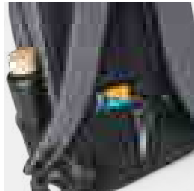

Brooklyn 92081

Waterproof 2 Tone Nylon computer backpack with padded shoulder straps. Featuring 2 compartments with padded dividers for computers up to 15" and tablets up to 10.5" and a self-adhesive hook and loop fastener. Front compartment with several interior pockets. Two pockets on the front, one of which has RFID protection. A bottle pocket on the side in spandex and opposite another for an umbrella which has mesh eyelets to prevent water accumulation. The padded back has a hidden pocket and trolley band. Capacity up to 14 L.

320 x 450 x 140 mm

TR5, TRD

Removable plate with magnet



Spacio 52675

2Tone Nylon waterproof laptop backpack with two lined compartments. The back compartment has an interior zipper pocket and padded dividers for a laptop up to 17". The front compartment has several interior pockets. Backpack with 2 front pockets and 2 side pockets, with an USB port and a USB/micro USB cable to connect with mobile devices (laptop battery not included). Padded back, with padded back support system and padded shoulder straps. Removable metal plate with magnet for easy engraving. Capacity up to 26 L.

310 x 470 x 200 mm

LSR, DOM, TRD, TR5



103

15,6"

Olympia 92276

840D Jacquard laptop backpack with 2 compartments. The back compartment is lined and has a padded laptop compartment up to 15.6". The front compartment is lined with several interior pockets. The backpack has side mesh pocket and front pocket. The back is padded and has padded back support and padded straps. Capacity up to 22 L.

± 305 x 470 x 180 mm
 TRS, TRD



104



123

17" 10,5"

Traveller 92674

High-density 600D tarpaulin laptop backpack with 2 compartments. The back compartment is lined with several interior pockets and 2 padded dividers for laptop up to 17" and for a tablet up to 10.5". The front compartment is lined and ideal for carrying clothes (or for leisure). The backpack has a front pocket and the back and straps are padded. Capacity up to 16 L.

± 300 x 430 x 150 mm
 TRS, TRD



104



133

14"

Kiev 92622

High density 600D laptop backpack. Main compartment with padded partition for laptop up to 14". The backpack has a zipped front pocket, padded straps and back. Capacity up to 13 L.

± 290 x 400 x 140 mm
 TRS, TRD



103



103



105



114

15,6"

Viena 92179

High-density 600D laptop backpack with main compartment with padded divider for laptop up to 15.6". The backpack has a zipped front pocket and the back and straps are padded. Capacity up to 10L.

± 290 x 370 x 110 mm
 TRS, TRD



Hidden closure for added security



Aveiro 92176

High density 900D and tarpaulin laptop backpack. Anti-theft system: main compartment with hidden zipper and back with 2 hidden pockets with metallic zippers, for greater security. Main padded and lined compartment, with 2 padded compartments for a laptop up to 15.6" and tablet up to 10.5". The backpack has several interior pockets, including the padded smartphone pocket, with access to the earphone outlet. Inside, it has cable management loops. On the side, the backpack has an outer zipped pocket and access to 1 inner pocket. The inner pocket is ideal for carrying a portable battery, making it easy to charge various mobile devices. Padded straps and back, with padded support system for the back, and 1 zipped pocket. Accessories not included. Capacity up to 25 L.

± 320 x 440 x 200 mm
 TRS TRD



Lunar 92164

600D high density laptop backpack. It has a compartment with 2 padded compartments for a laptop up to 15.6" and tablet up to 9.7". Its interior is lined and cushioned. It has 1 front pocket and 2 side pockets. The back is padded and has padded back support and padded straps. Capacity up to 14 L.

± 290 x 390 x 155 mm
 TRS TRD





104



103



104



Metz 92289

600D laptop bag. Compartment with partition for laptop up to 15.6" with lined and padded interior, with interior pockets. Contains a pocket on the front and has an adjustable shoulder strap with reinforcement.

400 x 290 x 50 mm

TR^S. TRD



103



103



104



Garbi 92197

Laptop bag in 600D polyester with line and padded interior to hold a 14" laptop, 1 main pocket and 2 additional pockets. Adjustable and reinforced shoulder strap

370 x 290 x 60 mm

TR^S. TRD



113



Santana 92266

Computer briefcase in 2 tone 600D and 300D with lined compartment and padded partition for a 15.5" computer. The briefcase has a front pocket with several interior compartments. On the back there is a trolley band. A reinforced adjustable padded shoulder strap.

400 x 295 x 75 mm

TR^S. TRD



119



103

104

105

119

Seoul 92257

Multifunction bag in 600D with open (lined) outer compartment with zipped front pocket, adjustable shoulder strap and reinforced hand straps.

400 x 300 x 100 mm

TR^S. EDB, ETD, TRD



Graphs Cross 92284

9.7" Tablet shoulder bag in high-density 600D with padded compartment for tablet protection. The interior is lined and padded. The bag has a front pocket, adjustable shoulder strap with padded reinforcement for comfort.

± 220 x 270 x 45 mm

➤ TRS, TRD



Graphs Laptop 92286

14" Laptop bag in high-density 600D padded lined compartment. It has a front pocket, adjustable shoulder strap, with padded reinforcement. The bag has a trolley band.

± 370 x 280 x 50 mm

➤ TRS, TRD



Graphs Bpack 92668

High density 600D laptop bag with padded compartment for laptop up to 15.6". The interior is lined and padded. The backpack has 2 front pockets, the back and straps are padded. Capacity up to 10 L.

± 295 x 390 x 100 mm

➤ TRS, TRD



Avery
92352

🏷️ .39



Shades Laptop 92171

Laptop bag in high density 600D. The main compartment is lined with padded divider to hold a 14" laptop. The bag has a front pocket, trolley carry strap and adjustable shoulder strap with padded reinforcement.

± 370 x 280 x 50 mm

➤ TRS, TRD



Shades Bpack 92170

600D high-density laptop backpack. The main compartment is lined and has 2 padded dividers for laptop up to 14" and tablet up to 9.7". The backpack has a front pocket, 1 side pocket. The back and the straps are padded. Capacity up to 12 L.

± 310 x 400 x 110 mm

➤ TRS, TRD





Doha 92236

Conference bag in 600D with zipper, ideal for carrying documents.

± 390 x 290 x 80 mm

➤ TRS, EDB, ETD, TRD



Milo 92316

Conference bag in 600D with 1 main pocket and zipper. Suitable for carrying documents.

± 390 x 300 x 40 mm

➤ TXP, TRD, TRS



Kayl 92357

Non-woven conference bag (80 g/m²) with 1 zipped compartment. Ideal for carrying documents.

± 380 x 300 mm

➤ TXP, TRD, TRS

Backpacks in Denim

Recognized for their strength and natural elegance.



Denim Bag 92095

Denim sports or travel bag (300 g/m²). Contains front pocket, double zipper and reinforced seams. It has cotton webbing handles and adjustable shoulder strap. Capacity up to 25 L.

∅ 260 x 480 mm

TR S LSR, TR D



Denim Casual 92093

Denim casual bag (300 g/m²). Contains 1 inside pocket with zipper, reinforced seams and 64 cm cotton webbing handles.

340 x 390 x 100 mm

TR S TR D



Denim Bpack 92094

Denim casual backpack (300 g/m²). Contains 2 front pockets and adjustable straps with cotton webbing. The interior seams are reinforced for extra strength. Capacity up to 8 L.

290 x 400 x 130 mm

TR S LSR, TR D

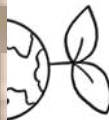
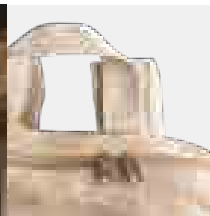

Padova
92937

.131



Marbella 92938

Juco backpack (275 g/m²) with a main compartment and a front zipper pocket. Cotton webbing handle on top and Bicolour cotton adjustable straps. Capacity up to 7 L.

270 x 350 x 70 mm

TR S TR D



Muzeul 92544

Waist pocket in high density 300D. Main compartment with zipper and inner pocket in elastic mesh. Back pocket with easy access, ideal for storing goods with greater security. Contains two front pockets, one with elastic mesh pocket, and an elastic on the side, suitable for hanging carabiners or sunglasses. The webbing strap is adjustable.

± 270 x 120 x 65 mm
 TRS, TRD



April 92545

Waist pouch in high density 600D. Main compartment and a zipper on the back of the pouch. This waist pouch has a webbing adjustable strap.

± 220 x 120 mm
 TRS, TRD



Lagos 92546

Waist pouch in high density 600D with main compartment and frontal pocket with zipper. This pouch has a webbing adjustable strap.

± 210 x 120 x 50 mm
 TRS, TRD



Lahore 92547

Shoulder bag in 600D with front pocket and adjustable shoulder strap.

± 180 x 220 x 70 mm
 TRS, TRD



Water reservoir with a capacity of up to 2L

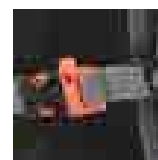

With whistle

Mounti 92628

420D sports backpack. Lined main compartment and zipped front pocket. Front panel with reflective elements. The back and straps of the backpack are padded to ensure greater comfort. Also on the back, it contains a strap with clips, to ensure that the backpack adjusts to the body, making it easier to carry in motion and suited for prolonged use. The backpack includes a straw and water tank with a capacity of up to 2 L. The backpack and the reservoir are supplied separately.

± 265 x 410 x 55 mm
 TRS, TRD



Light and practical



Logan 52635

600D backpack with front zippered front pocket. Back and padded straps, with padded back support system. Capacity up to 10 L.

245 x 400 x 115 mm

TR5, TRD

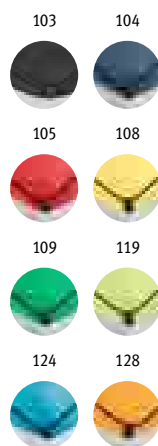

Turim 92471

600D backpack with mesh side pockets and inner pocket. The back and the straps are padded. Capacity up to 15 L.

250 x 420 x 180 mm

TR5, TRD



Barcelona 92669

210 ripstop foldable backpack with zipped front pocket. Backpack is supplied unfolded. Capacity up to 8 L.

295 x 415 x 110 mm | Folded: 160 x 130 mm

TR5, TRD

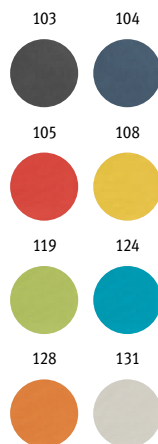

Berna 92667

600D backpack with zipped front pocket. Padded straps and back. Capacity up to 13 L.

310 x 410 x 120 mm

TR5, TRD

Sports bags that keep up with your rhythm

Multiple compartments mean you'll never be short of space for your training gear!

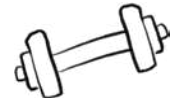

66 L



103

Giraldo 92520

300D polyester sports bag with adjustable shoulder strap, hard bottom, 1 main pocket and 4 additional pockets. Capacity up to 66 L.

⊞ 640 x 370 x 310 mm

➤ TRS, EDB, ETD, TRD

35 L



114

Detroit 92518

300D and 1680D sports bag with lined interior and bottom with semi-rigid board. The bag has 1 zippered front pocket and 2 side pockets: 1 mesh pocket and another zippered shoe pocket. The shoulder strap is adjustable and has padded reinforcement. Capacity up to 35 L.

⊞ 550 x 300 x 250 mm

➤ TRS, EDB, ETD, TRD



30 L



105



Fit 92511

600D sports bag with inner dividers and bottom with semi-rigid board. It has a front pocket and side pocket for shoes, both with zipper. This bag has an adjustable shoulder strap. Capacity up to 30 L.

⊞ 520 x 300 x 255 mm

➤ TRS, EDB, ETD, TRD

38 L



133



Busan 92567

600D sports bag with semi-rigid bottom. This bag has an adjustable reinforced padded shoulder strap. Capacity up to 38 L.

⊞ 550 x 310 x 260 mm

➤ TRS, EDB, ETD, TRD



The temperature of your meals is guaranteed with our thermal bags



Philadel 98420

 600D thermal bag that can be used in 2 different ways. Main compartment with double closure and PEVA lined and padded interior. Contains front zipped pocket and adjustable reinforced webbing straps. The bag has a capacity of up to 21 L.

480 x 330 x 180 mm | 310 x 240 x 180 mm

 TRS, TRD



Singapore 98418

 600D thermal bag with adjustable webbing strap and front pocket. Ideal to take to the beach. The bag has a capacity of up to 9 L.

240 x 220 x 170 mm

 TRS, TRD



Jaipur 98408

 600D cooler backpack with a capacity of up to 10 L. Includes a zipped front pocket and two side mesh pockets.

280 x 340 x 140 mm

 TRS, TRD



15 L

104



2 padded compartments

7 L

103



Boston Cooler 92096



Nylon 2Tone thermal bag with waterproof PEVA interior for easy cleaning. Contains 1 main compartment, 1 front zipped pocket and 1 side mesh pocket. It has a double main zippered pocket. The straps and the back are padded. The backpack has a capacity of up to 15 L.



± 290 x 380 x 160 mm

TR5, TRD



Zippers Cooler 92097



300D and 840D Jacquard thermal bag with waterproof PEVA interior for easy cleaning. Contains 2 main compartments, 1 front zipped pocket and 1 side mesh pocket. It has a double main zippered pocket, adjustable webbing strap and padded hand grip. The bag has a capacity of up to 7 L.



± 270 x 240 x 150 mm

TR5, TRD





129



11 L



129



Roma M 92184

Padded cooler bag in 600D PET (100% rPET) and ripstop. Composed of 1 large main compartment with double zip fastening on both sides and 2 side mesh pockets for small items. The PEVA-lined interior ensures good thermal insulation, allowing the cold to be kept in for longer and sanitised. The robust materials give it strength and durability, designed for everyday needs. Capacity up to 11 litres.

260 x 290 x 160 mm

TRD, TRS



104



129

16 L



104



Roma L 92099

Thermal backpack padded in 600D PET (100% rPET) and ripstop. It is made up of 2 front straps that make it easy to carry items, 1 spacious main compartment with double zip fastening on both sides, 2 side mesh pockets for small items and adjustable straps to ensure greater carrying comfort. The PEVA-lined interior ensures good thermal insulation, allowing the cold to be kept in for longer and sanitised. The robust materials give it strength and durability, designed for everyday needs. Capacity up to 16 litres.

280 x 400 x 160 mm

TRD, TRS

10 L



Rotterdam 98410

Non-woven cooler bag (80 g/m²) with self-adhesive hook and loop fastener and front pocket. The bag holds up to 10 L.

☒ 320 x 350 x 170 mm

➤ TRS, TRD

4 L



160

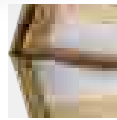

York 98428

Paper cooler bag up to 4 L with non-woven lining and interior with aluminium thermal insulation, and self-adhesive hook and loop fastener and front pocket.

☒ Closed: 195 x 350 x 110 mm |

☒ Open: 195 x 410 x 110 mm

➤ LSR, TRD, TRS

2 L



104



Osaka 98413

Foldable cooler bag in non-woven (80 g/m²) with a self-adhesive hook and loop fastener and a capacity up to 2 L. This bag is supplied unfolded.

☒ Folded: 170 x 95 x 40 mm |

☒ Open: 170 x 265 x 110 mm

➤ TRS, TRD

4,5 L



106

124



Turtle 58412

600D thermal bag with mesh interior pocket and adjustable webbing strap. With a capacity of up to 4.5 L.

☒ 200 x 200 x 110 mm

➤ TRS, TRD

3 L



105



Jeddah 98406

600D cooler bag for 6 0.33 L cans. Capacity up to 3 L.

☒ 200 x 140 x 125 mm

➤ TRS, TRD

3 L



108



Izmir 98409

Non-woven cooler bag (80 g/m²) with capacity for up to 6 cans of 0.33 L. Capacity up to 3 L.

☒ 180 x 140 x 130 mm

➤ TRS, TRD

SHOPPING



Recycled Cotton

Recycling of discarded cotton, whether in weaving, manufacturing or even post-consumer use. Recycled cotton avoids additional textile waste and requires fewer resources than conventional cotton.



Rynek 92920

Recycled cotton bag (70%) and recycled polyester (30%) (140 g/m²) with 65 cm handles.

375 x 415 mm

TXP, EDB, ETD, TRD, TRS



Maracay 92082

Bag with recycled cotton (70%), PET (30% rPET) (140 g/m²) and 68 cm handles.

380 x 410 x 100 mm

TXP, TRD, TRS



Parma 92330

Cotton (50%), recycled cotton (30%) and recycled polyester (20%) bag (280 g/m²) with 62 cm handles.

500 x 370 x 120 mm

TRS, EDB, ETD, TRD, TXP



Camden 92327

Cotton (50%), recycled cotton (30%) and recycled polyester (20%) bag (280 g/m²) with 62 cm handles.

500 x 370 x 120 mm

TRS, EDB, ETD, TRD, TXP





150



Girona 92331

Cotton (50%), recycled cotton (30%) and recycled polyester (20%) bag (220 g/ m²) with 60 cm handles.

± 380 x 400 x 100 mm

TR5, EDB, ETD, TRD, TXP



102

103

104

106



119

124

128

129



Merida 92326

Cotton (50%), recycled cotton (30%) and recycled polyester (20%) bag (220 g/ m²) with 62 cm handles.

± 380 x 400 x 100 mm

TR5, EDB, ETD, TRD, TXP



124

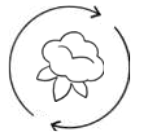



Cairo 92084

Bag (180 g/m²) in recycled cotton (70%) and PET (30% rPET) with 65 cm handles.

☒ 380 x 420 mm

🚚 **TRS** TRD, TXP

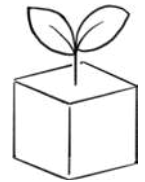

2 in 1 backpack bag

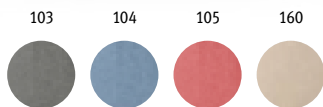

Rissani 92936

Drawstring bag with recycled cotton (70%) and recycled polyester (30%) (140 g/m²), 30 cm handles and cotton cords for closure.

☒ 370 x 410 mm

🚚 **TXP** TRD, TRS

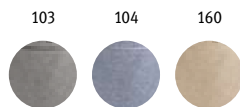

Chancery 92928

Drawstring bag in recycled cotton (70%), PET (30% rPET) (140 g/m²), with front pocket with discreet zipper and handles in cotton.

☒ 370 x 410 mm

🚚 **TXP** EDB, ETD, TRD, TRS

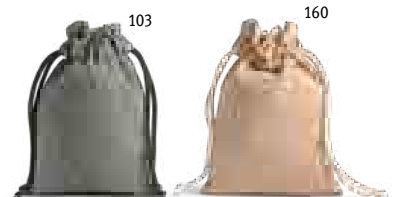

Gibraltar 92076

Recycled cotton gift bag (70%), PET (30% rPET) (140 g/m²) and cotton cord handles. Reusable bag ideal for small gifts.

☒ 140 x 200 mm

🚚 **TRS** TRD

Cotton bags

100% natural and versatile fibre that allows you to create highly durable pieces.



Denim Casual
92093
📄 .113



104



104

105

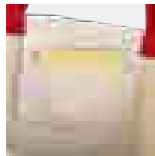

Inside pocket

Edmonton 92822

100% cotton canvas bag (280 g/m²) with inside pocket and 65 cm handles.

📏 460 x 400 x 150 mm

🔪 TXP, EDB, ETD, TRD, TRS



150



Inside pocket

Hackney 92926

100% cotton bag (280 g/m²) with zipper and inner pocket. Cotton webbing handles with 65 cm.

📏 Bag: 480 x 400 x 150 mm | Interior Pocket: 180 x 140 mm

🔪 TXP, EDB, ETD, TRD, TRS

Cuppari
94041
📄 .187



104



105



150



105

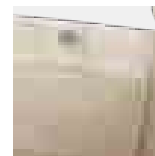

Inside pocket

Ville 92824

100% cotton canvas bag (280 g/m²) with front pocket, inside zip pocket and 60cm handles. This bag also contains a magnetic closure.

📏 530 x 380 x 170 mm

🔪 TRS, EDB, ETD, TRD

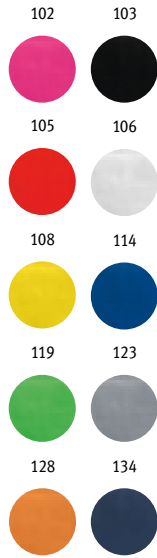

Wharf 92902
 100% cotton bag (100 g/m²) with 75 cm handles.
 370 x 410 mm
 TXP, EDB, ETD, TRD, TRS

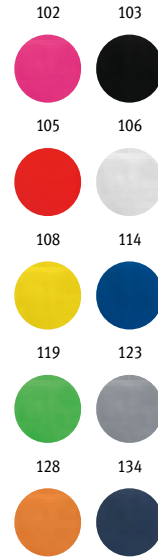

Caracas 92070
 100% cotton bag (140 g/m²) with 60 cm handles.
 375 x 415 mm
 TXP, EDB, ETD, TRD, TRS



Bondi 92821
 100% cotton bag (140 g/m²) with 60 cm handles.
 375 x 415 mm
 TRS, EDB, ETD, TRD, TXP



Regent 92414
 100% cotton bag (100 g/m²) with 75 cm handles.
 370 x 410 mm
 TRS, TRD, TXP



Victoria 92415
 100% cotton bag (100 g/m²) with 30 cm handles.
 370 x 410 mm
 TXP, EDB, ETD, TRD, TRS



Inside pocket



Beto 92820

100% cotton canvas bag (280 g/m²) with inside pocket and 65 cm handles.

☒ 450 x 380 x 105 mm

🔪 TXP, EDB, ETD, TRD, TRS

Cork handles



Feria 92869

100% cotton bag (180 g/m²) with 60 cm cork handles and inner pocket.

☒ 450 x 400 x 105 mm

🔪 TXP, EDB, ETD, TRD, TRS

Mesh front



Napoli 92935

100% cotton bag (120 g/m²) with 100% cotton mesh on the front (100 g/m²). With cotton rope for closure. Ideal to carry food.

☒ 300 x 400 mm

🔪 TRS, EDB, ETD, TRD



Mumbai 92927

100% cotton bag (180 g/m²) with 100% cotton mesh on the front. 65 cm webbing handles. Ideal bag for shopping.

☒ 390 x 430 x 80 mm

🔪 TXP, TRD, TRS





rPET

A material that distinguishes itself by being durable and not wearing out during use.



105



Pemba 92931

PET (100% rPET) 190T drawstring bag. With 40 cm handles.

370 x 410 mm

TXP, TRD, TRS

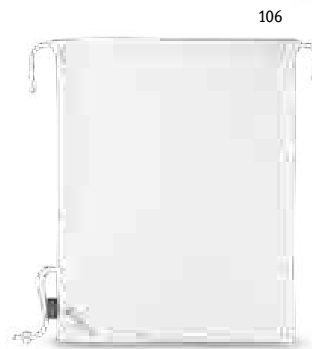

106

Foldable



Bolzano 92934

Foldable PET (100% rPET) mesh bag with 190T PET (100% rPET) pocket to fold the bag. Ideal for shopping.

320 x 400 mm

TRS, TRD

Beira
92930
.133



128



Maputo 92929

PET 190T (100% rPET) bag. Made from recycled plastic contributing to the reduction of waste in the environment. With 60 cm handles.

380 x 420 mm

TXP, TRD, TRS





Organic cotton

Cotton sourced from a sustainable crop without chemicals or pesticides.



Nampula 92933

100% organic cotton drawstring bag (120 g/m²).

± 370 x 410 mm

TXP, TRD, TRS



Matola 92932

100% organic cotton bag (120 g/m²). 60 cm handles and Organic Label.

± 370 x 410 mm

TXP, TRD, TRS

Jute and Cotton



Braga 92823

Jute bag - 100% - (240 g/m²) with 65cm handles and a front 100% cotton pocket (140 gsm).

☒ 370 x 410 x 100 mm | Pocket: 370 x 270 mm

🔧 TXP, TRD, TRS



Tizzy 92828

Jute shopping bag - 100% - (360 g/m²) with laminated interior and 60 cm webbing handles.

☒ 385 x 445 x 165 mm

🔧 TRS, TRD



Shanti 92827

Jute shopping bag - 100% - (360 g/m²) with laminated interior and short padded shoulder straps.

☒ 430 x 340 x 175 mm

🔧 TRS, TRD



Juco: an innovative fabric

The combination of cotton and jute results in a highly durable and resistant material: juco. A versatile fabric that is increasingly present in our daily lives.

Marbella

92938

 .113



160

Sablon 92919

100% cotton drawstring bag (160 g/m²) with an imitation jute detail and cotton handle.

 370 x 410 mm

 TXP, TRD, TRS



160

Mercat 92882

100% cotton bag (160 g/m²) with imitation jute detail and 65 cm handles.

 375 x 415 mm

 TXP, EDB, ETD, TRD, TRS



160



Padova 92937

Juco bag (275 g/m²) with 100% cotton (120 g/m²) inner zipper pocket. 60 cm handles in bicolour cotton webbing.

 370 x 410 x 90 mm

 TRS, TRD

Foldable bags

Ideal to carry with you in your bag, to go shopping or carry something last minute.



Mayfair 98423
 210D foldable cooler bag with 60 cm webbing handles and zipper. The bag has a capacity of up to 16 L. Supplied unfolded.
 Size: 400 x 440 x 130 mm
 TXP, TRD



Fola 92925
 190T polyester foldable shopping bag. Supplied unfolded.
 Size when opened: 485 x 420 mm | Folded: 120 x 100 mm
 TXP, TRD, TRS



Shops 92906
 190T foldable bag with 50 cm handles. This product is supplied unfolded.
 Size: 370 x 400 mm
 TXP, TRD, TRS



Arlon 92993
 Non-woven foldable bag (80 g/m²) with 38 cm handles. Product supplied folded (except if customised on the back).
 Size when opened: 380 x 465 mm | Folded: 200 x 110 x 15 mm
 TXP, TRD, TRS



Beirut 92332

Cotton (50%) and recycled cotton (30%) foldable bag (140 g/m²) with 38 cm handles.

Open: 380 x 470 mm | Folded: 135 x 205 mm

TRS EDB, ETD, TRD, TXP



150



103



104



Siena 92328

Foldable bag (140 g/m²) in cotton (50%) and recycled cotton (30%) with 38cm handles.

Open: 380 x 470 mm | Folded: 135 x 205 mm

TRS EDB, ETD, TRD, TXP



104

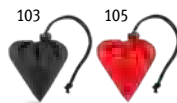

103

105

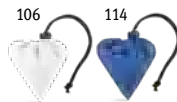

106

114

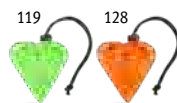

119

128



Beira 92930

PET 190T (100% rPET) foldable bag. With 40 cm handles.

Open: 370 x 420 mm

TXP TRD, TRS



128



150

Orleans 92922

100% cotton foldable bag (100 g/m²). This product is supplied unfolded.

Open: 370 x 400 mm

TXP EDB, ETD, TRD, TRS



102



119



102

103

104

105

106

108

114

119

124

128

132



102

103

105

106

108

109

114

119

123

124

128

132

134

Boxp 92904

Non-woven drawstring bag (80 g/m²) with drawstrings for closing. Available in a wide range of colours.

± 370 x 410 mm

TXP, TRD, TRS

Carnaby 92910

210D drawstring bag with black drawstrings to close the top. Available in a wide range of colours.

± 350 x 410 mm

TXP, TRD, TRS



127

Syros 92798

Reflective polyester drawstring bag (200 g/m²) with polyester handles.

± 320 x 400 mm

TRS, TRD, TXP



Romford 92913

100% cotton backpack-type bag (180 g/m²), with drawstrings to close at the top. Available in a wide range of colors.

350 x 430 mm

TXP, TRD, TRS

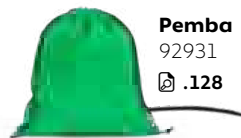

Pemba 92931

.128



Chancery 92928

.124



Rissani 92936

.124



Hanover 92456

100% cotton drawstring bag (103 g/m²).

370 x 410 mm

TXP, TRD, TRS



Ilford 92914

100% cotton backpack-type bag (100g/m²), with drawstrings to close at the top. Available in a wide range of colors.

370 x 410 mm

TXP, TRD, TRS



160

160

160

Tayla

Ellen

Leia

Tayla 92877

Kraft paper bag (115 g/m²) with twisted handle. Made in Europe. This product is made from FSC™ certified material and other controlled materials.

320 x 410 x 110 mm

TXP

Ellen 92876

Kraft paper bag (115 g/m²) with twisted handle. Made in Europe. This product is made from FSC™ certified material and other controlled materials.

240 x 310 x 90 mm

TXP

Leia 92875

Kraft paper bag (115 g/m²) with twisted handle. Made in Europe. This product is made from FSC™ certified material and other controlled materials.

230 x 180 x 80 mm

TXP



106

106

106

Grant

Cabazon

Citadel

Grant 92873

Kraft paper bag (100 g/m²) with twisted handle. Made in Europe. This product is made from FSC™ certified material and other controlled materials.

320 x 410 x 110 mm

TXP

Cabazon 92872

Kraft paper bag (90 g/m²) with twisted handle. Made in Europe. This product is made from FSC™ certified material and other controlled materials.

240 x 310 x 90 mm

TXP

Citadel 92871

Kraft paper bag (90 g/m²) with twisted handle. Made in Europe. This product is made from FSC™ certified material and other controlled materials.

230 x 180 x 80 mm

TXP



Cuppari

94041

.187

PAPER'IN

Be unique! Create your own bag.

.320



The mark of responsible forestry
FSC® C178434

Kira 92878

Kraft paper bag (115 g/m²) with twisted handle. Made in Europe. This product is made from FSC™ certified material and other controlled materials.

400 x 360 x 120 mm

TXP

Kelly 92874

Kraft paper bag (100 g/m²) with twisted handle. Made in Europe. This product is made from FSC™ certified material and other controlled materials.

400 x 360 x 120 mm

TXP



Kira

Kelly



Canary 92839

Thermo sealed non-woven bag (80 g/m²) with 75 cm handles.

380 x 415 x 85 mm

TXP, TRD, TRS



Macy 92854

Thermo sealed non-woven bag (80 g/m²) with 55cm handles.

270 x 350 mm

TXP, TRD, TRS



Notting 92895

Thermo sealed non-woven bag (80 g/m²) with 38 cm handles.

380 x 415 x 85 mm



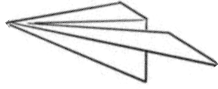

TXP, TRD, TRS



Ideal for travelling

The essential bag to take with you in your trolley.



- 104 
- 105 
- 119 
- 131 



Shopper 92843

Non-woven bag (80 g/m²) with 50cm handles.

⊞ 400 x 340 x 200 mm

TXP TRD, TRS



Arasta 92924

Non-woven bag with shiny lamination (140 g/m²) with zipper. The bag has a trolley band, reinforced bottom and 65 cm webbing handle.

⊞ 350 x 350 x 200 mm

TXP









Sawgrass 92850

Non-woven laminated bag (90 g/m²) with 50cm handles and glossy lamination.

⊞ 340 x 350 x 80 mm

TXP



- 103 
- 104 
- 105 
- 106 
- 119 
- 124 
- 128 

Millenia 92833

Non-woven laminated bag (110 g/m²) with 60cm handles and glossy lamination.

⊞ 400 x 360 x 120 mm

TXP

102



Stratford 92499

Thermo sealed non-woven bag (80 g/m²).

± 355 x 390 x 85 mm

TXP, TRD, TRS

104

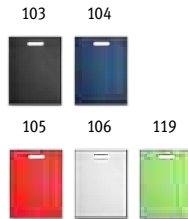

Rotterdam 92845

Thermo sealed non-woven bag (80 g/m²).

± 250 x 350 x 80 mm

TXP, TRD, TRS

104



105

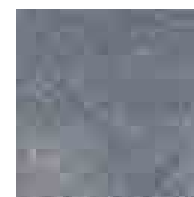

With printed pattern

Tarabuco 92921

Thermo sealed non-woven bag (80g/m²) with printed pattern and a bottom gusset of 85 mm.

± 380 x 415 x 85 mm

TXP, TRD, TRS

SPORTS & OUTDOOR



With thermal bottle bag

Polar fabric blanket



With thermal bottle bag



Villa 98422

High density 600D picnic cooler backpack. Removable blanket and thermos pouch. The main compartment is padded and has thermal coating. The front pocket, lined with 210D and padded, has a removable utensil holder, which includes 12 stainless steel cutlery (4 forks, 4 knives and 4 spoons), 4 plates, 4 PS cups, 4 cotton napkins (100%), 1 salt shaker, 1 pepper shaker, 1 PP board and 1 corkscrew. The thermos pouch and the main compartment are fully lined (with PEVA) and padded. The blanket is made of polar fabric 160 g/m², lined with PEVA.

300 x 410 x 230 mm | Bottle pouch: Ø105 x 300 mm | Blanket: 1500 x 1350 mm

TR5 TRD

Arbor 98421

600D picnic cooler backpack with removable thermos pouch. Main compartment padded with thermal coating. Front pocket lined with 210D and padded. Includes 6 stainless steel cutlery (2 forks, 2 knives and 2 spoons), 2 plates, 2 PS glasses and 1 corkscrew. The thermos pouch and main compartment are fully lined (with PEVA) and padded.

280 x 390 x 180 mm | Bottle pouch: Ø105 x 300 mm

TR5 TRD



109



Lined interior

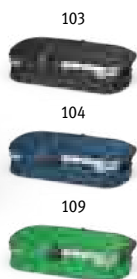

103

104

109

Baskit 98426

Flexible picnic basket in 600D. This basket has a double zipper and a lined interior. Basket with aluminium removable frame, ergonomic EVA handle and capacity up to 14L.

460 x 270 x 250 mm

TR5 TRD

Net support for bottle



103

Throne 98131

Foldable chair in 600D with mesh bottle holder. Metal construction that supports up to 100Kg. Supplied in a pouch with a strap.

Unfolded: 520 x 520 x 830 mm | Folded: 830 x 160 mm

TR5 TRD





Riley II 99088

Fleece blanket (180 g/m²) lined in EPE with 600D flap. Includes handle for easy transport. Square patterned blanket. Ideal for outdoor activities.

⌘ Folded: 330 x 230 mm | Flap: 300 x 200 mm

🔪 TRD, EDB, ETD, TRS

Adjustable handle and strap

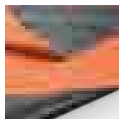

104 105 128



Fleece 99077

Polar fleece blanket (160 g/m²) lined with EPE, with handle and adjustable strap.

⌘ 1500 x 1200 mm | Folded: Ø150 x 315 mm

🔪 TRS, EDB, ETD, TRD



103 104 105



119 128 131



Thorpe 99074

Fleece blanket (180 g/m²) with removable handle for easy carrying. Available in a wide range of colours.

⌘ 1500 x 1200 mm

🔪 TRS, EDB, ETD, TRD



104 105 119

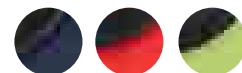

Riley 99076

Polar fleece blanket (180 g/m²) lined with EPE, with 600D flap and carrying handle.

⌘ 1450 x 1200 mm | Folded: 330 x 230 mm | Flap: 300 x 200 mm

🔪 TRS, EDB, ETD, TRD

Practice your favourite sport with the best accessories

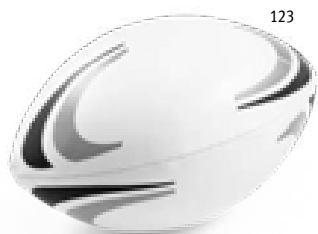

123

Lomu 98269
Rugby ball with grey and black details.
Size 4
TR5, TRD

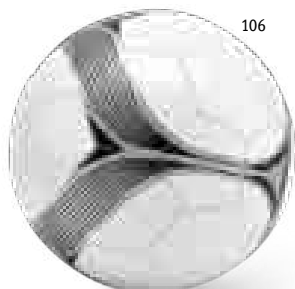

106

Walker 98135
Football with a classic design.
Size 5
TR5, TRD



104

Nanga 98136
Volleyball with blue and white stripes.
Size 5
TR5, TRD



103

106

Bryce 98132
Football with a classic design.
Size 5
TR5, TRD



124



Zion 98137
EVA exercise mat for yoga. Up to 4mm thick. Includes polyester bag with netting to prevent odours and an adjustable carrying strap.
Closed: Ø115 x 635 mm | Open: 1830 x 610 x 4 mm
TR5, TRD, TXP



103

Burpee 99970
Set of 4 fitness bands supplied in a black non-woven pouch. Each band has a different strength: Red - strong; Yellow - medium; Blue - low; Green - very low.
Pouch: 100 x 200 mm
TR5, TRD

4 levels of resistance



Very light



Light



Medium



Strong

Yoga accessories



160



160



MADE IN EUROPE

Yala 98139

Cork exercise block. Ideal for yoga and aerobics. Contains paper strip with exercise instructions. Made in Europe.

📏 227 x 120 x 75 mm

🔪 **SCR**, LSR



Geres 98138

Exercise mat for yoga made of cork and TPE. Up to 3,7 mm thick. It includes a carrying handle and a paper bag illustrating exercises.

📏 Closed: Ø100 x 610 mm | Open: 1830 x 610 x 3,7 mm

🔪 **LSR**

Sport towels

Your ally to cool off during physical activity.

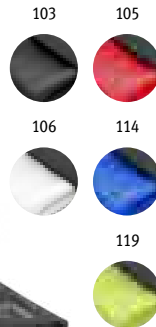

Bernal 99969

PET (100% rPET) fitness cooling towel. Supplied with a black non-woven pouch. Reusable towel, machine washable.

⌘ Towel: 300 x 800 mm | Pouch: 90 x 200 mm
 ↗ TRS, TRD

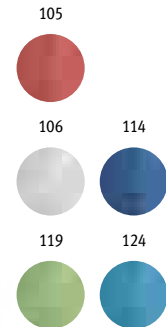

Artx Plus 99967

Set with a PP and rPET bottle and a polyamide and polyester sports towel. Bottle with handle, practical to be taken anywhere and capacity up to 440 mL. Refreshing towel that, when wet, stays cool for a few hours. If it warms up, just shake it, reactivating its freshness. The towel is reusable and washable in the washing machine.

⌘ Towel: 300 x 800 mm | Bottle: Ø65 x 183 mm
 ↗ PDP, SCR, TRD, TRS

Reflective elements

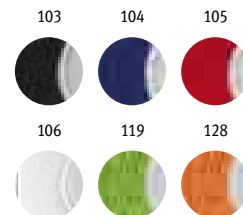

Confor 97207

High-density soft shell and PU armband for smartphone up to 6.5". The armband has reflective elements and adjustable closure. This is a promotional product.

⌘ 440 x 175 mm
 ↗ SCR

Kov 99022

Polyester wrist band with appropriate area for customisation.

⌘ 75 x 78 mm
 ↗ TRS, TRD



With metal hook

103



104



129



131



MADE IN EUROPE

Golfi 99964

Multifunctional cotton towel (430 g/m²) with metal hook. Soft to the skin and very absorbent, it is ideal to accompany sports such as golf or for use in the kitchen. Practical for hanging thanks to the easy-to-use hook. Made in Europe.

380 x 500 mm | Strip: 380 x 42 mm

TR S, EDB, ETD, TRD



106



124

Travis 99966

Microfibre sports towel (210 g/m²). Practical and light towel that facilitates transport, with high absorption and quick drying. Supplied with a 190T pouch.

400 x 800 mm | Pouch: 135 x 205 mm

TR S, EDB, ETD, TRD



106

MADE IN EUROPE

Cancha 99962

Cotton sports towel (380 g/m²). Made in Europe.

300 x 500 mm | Strip: 300 x 56 mm

TR S, EDB, ETD, TRD



106

MADE IN EUROPE

Gehrig 99963

Cotton sports towel (380 g/m²). Made in Europe.

500 x 800 mm | Strip: 500 x 75 mm

TR S, EDB, ETD, TRD

Know how to orient yourself

Nature activities can be challenging, so it's always helpful to have a compass nearby.



Alasca 92092
 .101

Observation slot and magnifying glass



Zikmund 98816
 ABS compass with observation slot on the lid and magnifying glass. Gold details.
 ∓ ∅55 x 25 mm





Galiley 98808
 Compass with cover and ring. Light and easy to carry.
 ∓ ∅45 x 15 mm
 PDP DUV, SCR



Adjustable positioning



LED Stany 94747
 Head torch with elastic ribbon. Adjustable torch with 8 white LEDs and 2 red LEDs and flash function. Includes 3 AAA batteries.
 ∓ 80 x 40 x 60 mm



For sports lovers

Choose the best tool for your bike.



Roglic 94009

Bike tool kit with 11 wrenches, 2 tyre levers, 6 tyre patches, glue tube and scraper. Supplied in a 600D bag.

📏 Pouch: 95 x 120 x 36 mm

🏢 TRS, TRD

Mounti 92628

📏 .114



103



106



134

Adjustable positioning



134



Bartali 99009

PET 210D (100% rPET) bicycle seat cover.

📏 265 x 240 mm

🏢 TRS, TRD



Be seen from any distance



Jones 99418

Polyester cap with reflective elements, ventilation holes and adjustable closure with self-adhesive hook and loop fastener. Promotional product.

Size: 580 mm

TR5, EDB, ETD, TRD

Berry
93339
.276



Visible 98515

Reflective armband with 4 red LEDs, flash function. Adjustable with self-adhesive hook and loop fastener.

30 x 410 mm

PDP



Nibali 98821

Reflective light with 3 LEDs, 3 light modes and carabiner. This light includes 2 CR1220 batteries.

55 x 75 mm

PDP, SCR

Velvet lining

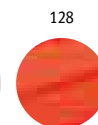

Rafael 98505

Fluorescent bracelet with velvet lining. This is a promotional product.

300 x 30 mm

PDP



Mike 98501

100% polyester reflective kids' vests. This product features 2 horizontal reflective bands, a side self-adhesive hook and loop fastener and has EN 17353 certification.

☿ One size: 370 x 470 mm

🔪 TRS, TRD, TXP

Thiem 98502

100% polyester high visibility vest certified with EN 17353. Reflective vest with 2 horizontal reflective bands and elastics on the side.

☿ One size: 540 x 620 mm

🔪 TRS, TRD, TXP

Yellowstone 98503

100% polyester high visibility vest certified with EN ISO 20471 class 2. Reflective vest with 2 horizontal reflective bands and a self-adhesive hook and loop fastener front opening.

☿ One size: 670 x 700 mm

🔪 TXP, TRD, TRS

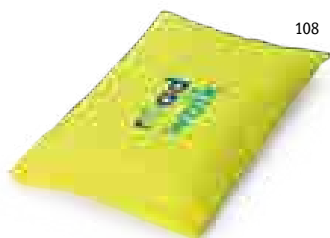

Roger 98504

100% Polyester pouch with a self-adhesive hook and loop fastener. Suitable for vest 98503.

☿ 145 x 220 mm

🔪 TRS, TRD

Rules 92835

210D drawstring bag with reflective elements. This is a promotional product.

☿ 350 x 400 mm

🔪 TXP, TRD, TRS

Illusion 98510

Waterproof backpack protection in 210D with reflective elements. This is a promotional product.

☿ 660 x 770 mm

🔪 TXP, TRD, TRS



147

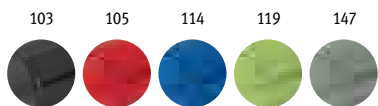

Flashy 94736

Aluminum flashlight with 9 LEDs and handle. Includes 3 AAA batteries. Available in a wide range of colors.

∅26 x 90 mm

LSR



Zoom function with 3 light modes

105

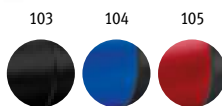

Zoomin 94758

Aluminium torch with zoom function with 3 light modes, 1 W LED lamp and handle. Includes 3 AAA batteries. Supplied in a gift box.

∅33 x 103 mm | Box: 115 x 43 x 40 mm

LSR, PDP



104

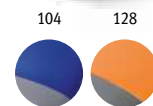

Eddie 94720

Dynamo torch with 3 LEDs and wristband. To use the light with the dynamo power, you must continue to press the side tab. To use the light with battery power you must press the side button (either to turn it on or off). Includes 3 AG10 batteries.

100 x 50 x 25 mm

PDP, SCR

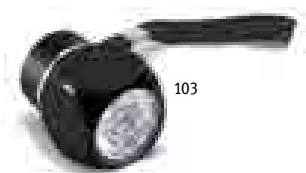

103



105



114

Louis 94732

Aluminium torch with 6 LEDs and handle. Includes 2 CR2032 batteries.

28 x 40 x 28 mm

LSR



105

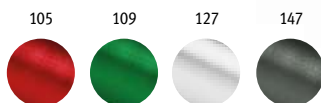

Torchen 93267

Metal torch with 3 LEDs, bottle opener and keyring. Includes 3 LR44 batteries.

∅18 x 72 mm

LSR



With decapsulator and magnet

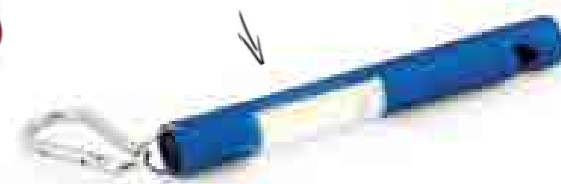

114

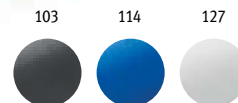

Corts 94745

Aluminium torch with COB LED, bottle opener, carabiner and magnet on the tip. Includes 5 LR44 batteries.

∅15 x 130 mm

LSR, PDP



Flashlight 2 in 1



104 123



Pavia 94739

ABS flashlight with LED COB, hanging hook and magnet. Includes 3 AA batteries.

± 61 x 200 x 35 mm

➤ PDP

Olympos 98143

2-in-1 lantern in ABS and PS. 2 modes of use: outdoor or camping lamp, which allows you to illuminate large areas or as a lantern using the side handle which is also removable. The torch has a COB led (200 lumens) and 1W LED. Ideal for camping or outdoor activities. Includes 3 AA batteries. Supplied in a gift box.

± 87 x 140 mm

➤ PDP

Extendable and flexible



103

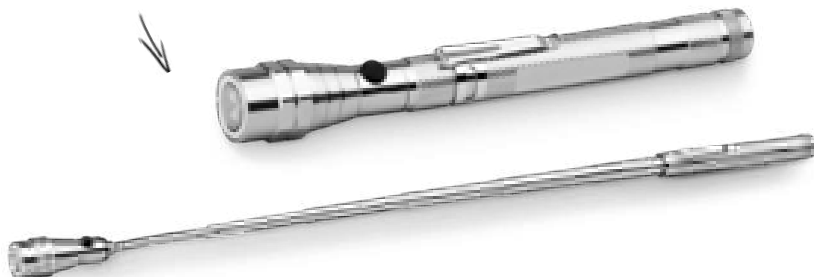

107

Granja 94738

Aluminium torch with LED. The flashlight includes 2 AA batteries and is supplied in a gift box.

± Ø29 x 163 mm | Box: 35 x 175 x 35 mm

➤ LSR, DOM

Nobend 94749

Extendable and flexible metal LED torch with 3 LEDs, magnet on the tip and clip. Includes 4 LR44 lithium batteries.

± Ø22 x 175 mm

➤ LSR, DOM

Be prepared to solve any unforeseen issues

With **20** functions



Inox **Magnum** 94022

Folding pliers with multi-function tools in stainless steel and wood. Includes 20 functions: pliers, screwdriver, bit and 10x bit adapter, leather awl, bottle opener, ruler, fish scale, hook puller, PH screwdriver, flathead screwdriver, knife and screw. Supplied in polyester bag.

45 x 100 x 25 mm | Pouch: 65 x 140 x 30 mm

LSR, PDP



Inox **Dunito** 94016

Folding mini multi-function pliers made of stainless steel and aluminum. Includes 9 functions: pliers, saw blade, 2 openers, cross head screw, knife, flat head screwdriver (large and small) and nail file. Supplied in 600D pouch.

Closed: 35 x 70 x 18 mm | Pouch: 50 x 90 x 20 mm

LSR, PDP





Inox **Belpiano** 94159

Multifunction pocket knife in stainless steel and wood. Includes 5 functions: corkscrew, awl, bottle and can opener, and knife.

∓ 90 x 25 x 12 mm

➤ **LSR**, PDP



Inox **Kaprun** 94147

Multi-function pocket knife made of stainless steel and metal. Includes 11 functions: corkscrew, sewing eye, nail file, punch, PH screwdriver, bottle and can opener, scissors, fish scaler and hook spreader, wood saw and knife.

∓ 90 x 25 x 18 mm

➤ **LSR**, PDP

With mini flashlight



LED **Inox** **Solden** 94131

Multifunction pocket knife in stainless steel and metal with mini LED flashlight. The pocket knife has 11 functions: PH screwdriver, punch, nail file, sewing eye, corkscrew, LED light, scissors, wood saw, knife, bottle and can opener. Includes 3 AG10 batteries.

∓ 90 x 20 x 27 mm

➤ **LSR**

Stores parts on the top



In steel and carbon

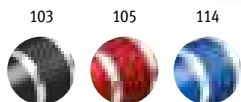

Toolpen 94014

Pen shaped screwdriver set with 8 different removable tips. Practical tool with clip and the option to store all the components on the upper part of the body with lid.

∓ Ø16 x 109 mm

➤ **LAS**, LSR, PDP



Tuff 94019

45-piece carbon steel and PE tool set. Supplied in a case.

∓ 220 x 115 x 55 mm

➤ **PDP**, DOM, STI



Good allies

The pocket knife is one of the most useful accessories during outdoor activities such as camping, mountaineering, and fishing. Preferably with security locks for added protection.



Inox **Ninja** 94036

Pocket knife in stainless steel and metal with safety lock and clip. Supplied in a gift box.

± 115 x 15 x 32 mm | Box: 125 x 42 x 20 mm

LSR, PDP



Inox **Fred** 94037

Pocket knife in stainless steel and metal with safety lock and carabiner. Supplied in a gift box.

± 101 x 10 x 29 mm | Box: 108 x 39 x 15 mm

LSR, PDP



12 functions

Inox **Wild** 94040

Multi-function pocket knife in stainless steel. Includes 12 functions: carabiner, corkscrew, reamer and countersink in AWL, nail file, leather punch, screwdriver, bottle opener, can opener, scissors, fish scale and hook remover, wood saw and knife. Supplied in a gift box.

± 89 x 16 x 32 mm | Box: 104 x 39 x 20 mm

LSR, PDP



Inox **Alick** 94035

Pocket knife in stainless steel and metal with safety lock and clip. Supplied in a gift box.

± 97 x 15 x 29 mm | Box: 110 x 37 x 20 mm

LSR, PDP



170



Norris 94032

Inox  Stainless steel and wooden hunting knife. Supplied in a gift box.

 300 x 19 x 60 mm

 LSR, PDP



170



Lawrence 94030

Inox  Pocket knife in stainless steel and wood with security lock and clip.

 115 x 16 x 36 mm

 LSR

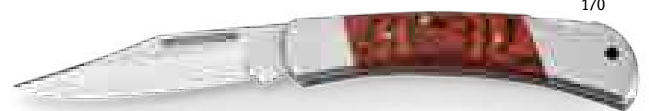

170



Falcon II 94031

Inox  Pocket knife in stainless steel and wood with security lock.

 110 x 19 x 30 mm

 LSR, PDP

Ideal for cutting mushrooms



160



Gunter 94033

Inox  Pocket knife in stainless steel and wood with carabiner. Supplied in a gift box.

 115 x 13 x 26 mm

 PDP



160



Split 94038

Inox  Pocket knife in stainless steel and wood with security lock. Supplied in a gift box.

 84 x 11 x 24 mm | Box: 94 x 33 x 16 mm

 LSR, PDP



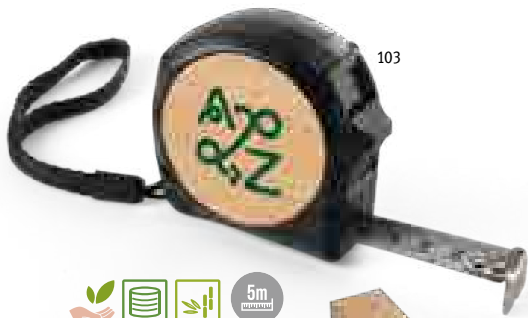

103



Odense V 98145

5 metre tapemeasure made from 100% recycled ABS and bamboo. Contains brake, metal clip and loop to attach to wrist. Supplied in a kraft paper gift box.

± 35 x 33 x 19 mm

✓ SCR, LSR



107



Meribel III 94228

MID certified 3 m tape measure with brake, metal clip and wrist loop.

± 72 x 52 x 26 mm

✓ DOM



Meribel V 94229

MID certified 5 metre tape measure with brake, metal clip and wrist loop.

± 88 x 61 x 31 mm

✓ DOM



108



Vancouver III 94232

MID certified 3m tape measure with ABS brake, metal clip and nylon wrist loop.

± 74 x 55 x 38 mm

✓ PDP, DOM



114



Guliver III 94210

3 Metre ABS tape measure with brake, metal clip, and wrist loop.

± 60 x 60 x 35 mm

✓ PDP, DOM



105

108

114



Guliver V 94230

5 Metre ABS tape measure with brake and metal clip, with wrist loop.

± 75 x 70 x 40 mm

✓ PDP, DOM



119

Payton 94510

Utility knife with locking mechanism for security and removable top for blade adjustment. Coloured body.

± 155 x 30 x 10 mm

✓ PDP

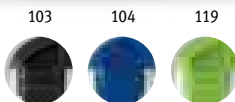

103

104

119



Grafit

91768

± .88



105

Balic 94501

Utility knife with locking mechanism for security and removable top for blade adjustment. Coloured body.

± 130 x 20 x 8 mm

✓ PDP

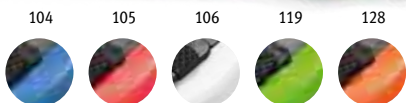

104

105

106

119

128



Grafit Colour

91725

± .88



107



Cradle 98142

PE bubble car sun shade with padded aluminium sheet on the front and back. Suitable for front window and includes 2 suction cup fasteners. Foldable for easy storage.

± 1300 x 600 mm

➤ TXP



108

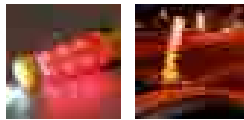

Flashmer 94759

Hammer with magnet, car seat belt cutter and flashlight with 1 white LED and 3 red LEDs. Includes 2AA batteries. Supplied in a gift box.

± Ø38 x 193 mm

➤ PDP, DOM



103



Dig 94760

Metal foldable shovel with compass and rubber grip. Practical and compact. Useful for removing ice or snow. Supplied in 600D pouch.

± Folded: 160 x 100 mm | Open: 420 x 100 mm

➤ LSR, PDP, TRD, TRS

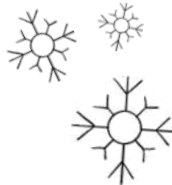

114

Soldeu 98122

Ice scraper with glove. The upper part of the glove is made of cotton ensuring greater comfort in use.

± 165 x 270 x 13 mm

➤ PDP, TRD, TRS



105

114

Amigo 98184

Ice scraper with handle and brush.

± 400 x 70 x 100 mm

➤ PDP



160

Spree 98133

Ice scraper in PP (60%) and wheat straw (40%).

± 235 x 105 mm

➤ PDP



108



114



128



Seccur 94970

Tamper proof satin bracelet with security clasp. Available in a wide range of colours.

± 320 x 15 mm

✓ SCR, TRD, TRS

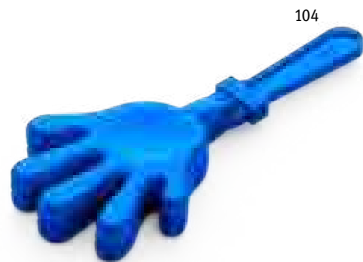

104

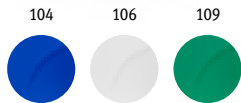

Clappy 98073

Hand-shaped clapper (PS). Ideal for theme parties and games. Available in a wide range of colours.

± 85 x 185 x 19 mm

✓ PDP, DUV



109

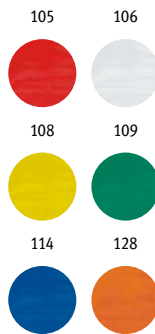

Sainz 98454

Pair of inflatable sticks, hand clappers (PE).

± 600 x 100 mm

✓ TXP

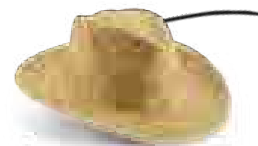

Jean

99419

☒ .298



Kane

94324

☒ .186



103

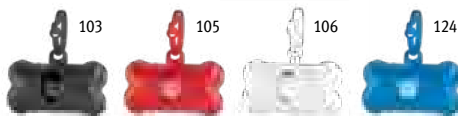

Trotte 95103

Bone-shaped PP dog bag dispenser including 20 PE hygienic dog bags.

± Closed: 111 x 21 x 15 mm

✓ PDP



DRINKWARE



Materials such as bamboo provide resistance and originality, making each bottle unique



2 stainless steel infusers



Makarova 94765

Double-walled borosilicate glass travel cup with bamboo lid. Includes 2 stainless steel infusers. The bottle has a volume-capacity up to 490 mL. Suitable for dishwasher, once lid is removed. Supplied in a paper kraft box.

± Ø72 x 234 mm
 LSR, PDP, SCR



Pietro 94241

Stainless steel and bamboo travel cup with air-insulated double wall and sliding opening system. Capacity up to 500 mL. Supplied in a kraft paper gift box.

Inox
 ± Ø82 x 158 mm
 PDP, LSR



Sliding lid



Lycka 94761

Air-insulated double wall stainless steel and bamboo cup with AS lid with slide closure. Capacity up to 350 mL. Supplied in a kraft paper gift box.

± Ø80 x 108 mm
 LSR, DUV, SCR





Double wall
vacuum insulated



Sow 94239

Bamboo and stainless steel thermal bottle with vacuum double body and tea infuser. This bottle has a capacity up to 440 mL and is supplied in a kraft paper gift box.

Inox \pm Ø70 x 215 mm

➤ **DUV**, LSR, SCR



160



160



Naturel 94683

Double-walled bamboo and stainless steel thermal bottle with tea infuser. This bottle has a volume-capacity up to 430 mL and is supplied in a gift box.

Inox \pm Ø69 x 207 mm | Box: 72 x 210 x 72 mm

➤ **LSR**, DUV, SCR



103



Laver 94257

Bamboo and stainless steel bottle with a PP lid, double-walled body and vacuum insulation. Capacity of up to 440ml. Supplied in a kraft paper gift box.

Inox \pm Ø70 x 222 mm

➤ **DUV**, LSR, SCR



160



Ceylon 94254

Bamboo and stainless steel vacuum-insulated double-walled thermos. The bottle has a capacity of up to 450 mL and keeps drinks hot for 12 hours and cold for 24 hours. Supplied in a kraft paper gift box.

Inox \pm Ø63 x 251 mm

➤ **LSR**, SCR





Morgan 94271



Single walled bottle made from recycled stainless steel (90%). The lid has a patterned handle. Capacity up to 710 mL. Supplied in a kraft paper gift box.

∅70 x 232 mm

LAS SCR



Double wall vacuum insulated



Norton 94316



Stainless steel bottle with vacuum insulated double wall. The cap includes a PP drinker with straw. Capacity up to 570 mL. Supplied in kraft paper gift box.

∅58 x 240 mm

LSR. DUV, SCR, UVC





Recycled stainless steel

A recycled material that does not compromise its strength, quality and durability.

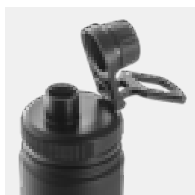

Federer 94272

Double-walled bottle in (90% recycled) stainless steel and PP cap. The lid has a screw and a handle for easy transport. Capacity up to 570 mL. Supplied in a kraft paper gift box.



Inox ± Ø73 x 227 mm

LAS, SCR



Rubber finish



Double wall vacuum insulated

+ 0,5L



24h
8H



Odin 94603

Double wall vacuum stainless steel bottle with rubber coating, screw-on lid and capacity up to 550 mL. Supplied in a gift box.

± Ø70 x 220 mm

Inox PDP, SCR, UVC



+ 0,5L



24h
8H



Ragnar 94602

Double wall stainless steel vacuum bottle and capacity up to 570 mL. Includes screw on lid with bamboo and stainless steel carry handle. Supplied in a kraft paper gift box.

± Ø70 x 220 mm | Box: 75 x 227 x 75 mm

LSR, DUV, PDP, SCR, UVC





Show Satin 94771

Double wall stainless steel vacuum bottle, capacity up to 540 mL, leakproof and screw-on lid. Supplied in a gift box.

± Ø71 x 255 mm

✓ LSR, DUV, LAS, SCR, UVC



Solberg 94240

Double-walled vacuum insulated stainless steel bottle with cork base. Keeps drinks hot for 8h and cold for 24h. Capacity up to 560 mL. Supplied in a kraft paper gift box.

± Ø71 x 258 mm

✓ LAS, DUV, LSR, SCR, UVC



Solberg Tumbler 94327

± .182

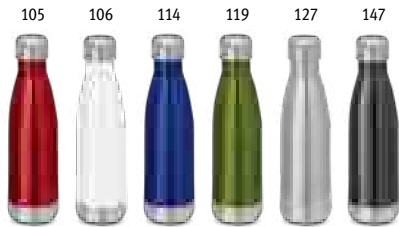

Show 94550

Double wall stainless steel vacuum bottle with screw-on, leak proof lid. Volume-capacity 510 mL. Supplied in a gift box.

± Ø67 x 255 mm

✓ LAS, DUV, LSR, SCR, UVC



Buffon 94078

Double wall stainless steel vacuum bottle with leak proof screw-on lid. Capacity up to 500ml. Supplied in a gift box.

± Ø67 x 255 mm | Box: 75 x 75 x 275 mm

✓ LSR, DUV, LAS, SCR, UVC





0,6l



Lavine 600 94262
 Stainless steel vacuum-insulated double-walled thermos flask with a copper-coated inner wall and cork stopper. Bottle with capacity up to 600 mL and keeps drinks hot for 16h and cold for 57h. Supplied in a kraft paper gift box.
 Inox \pm Ø73 x 197 mm
 PDP, LAS, LSR, SCR



Lavine 350 94263
 Stainless steel vacuum-insulated double-walled travel cup, with copper coated inner wall and cork lid. Cup with capacity up to 350 mL and keeps drinks hot for 8h and cold for 48h. Supplied in a kraft paper gift box.
 Inox \pm Ø73 x 125 mm
 PDP, LAS, LSR, SCR





Copper vacuum insulated

The ideal bottles to maintain your drink's temperature



Norre Bottle 94662

Double wall stainless steel vacuum bottle with internal wall with copper coat. Bamboo lid and silicone ring for extra protection. The bottle has capacity up to 640 mL and keeps drinks hot for 16 h and cold for 48 h. It also has a powder coating which gives it more durability and strength. Supplied in a kraft paper gift box.

∅72 x 233 mm
LSR, PDP, SCR

Silicone-insulated lid



Norre Tumbler 94661

Double wall stainless steel vacuum cup with internal wall with copper coat. Bamboo lid and silicone ring for extra protection. The cup has capacity up to 370 mL and keeps drinks hot for 5 h and cold for 24 h. It also has a powder coating which gives it more durability and strength. Supplied in a kraft paper gift box.

∅80 x 106 mm
LSR, PDP, SCR



24h
12h



Liter 94679

Stainless steel thermos flask with vacuum insulation and volume-capacity of 1000 mL. Supplied in a gift box.

∓ Ø82 x 330 mm

Inox / LSR, LAS, SCR, SND



24h
12h



Karpov 94610

Double wall stainless steel vacuum insulation bottle with volume-capacity of 500 mL. Supplied in a gift box.

∓ Ø69 x 240 mm

Inox / LSR, LSR, SCR, UVC



24h
12h



Heat 94667

Stainless steel thermos flask with vacuum insulation and volume-capacity of 750 mL. Includes 2 cups. Supplied in a gift box.

∓ Ø86 x 310 mm

Inox / LSR, SCR, UVC



24h
12h



Durant 94609

Set with thermal bottle and stainless steel mugs. The set includes 2 mugs with volume-capacity of 200 mL, double walled bottle with volume-capacity up to 500 mL and a 600D pouch with adjustable strap.

∓ Pouch: 155 x 250 x 90 mm

Inox / LSR, LAS, SCR, TRD, TRS, UVC



24h
12h



Luka 94615

Double wall stainless steel vacuum insulation bottle with volume-capacity of 500 mL. Supplied in a gift box.

∓ Ø69 x 240 mm

Inox / LSR, LAS, SCR, UVC



Tea infuser

Digital thermometer



24h
12h

Safe 94680

Stainless steel and PP thermal bottle with double vacuum insulated body and capacity up to 490 mL. Includes a cup. Supplied in a gift box.

Inox \pm Ø68 x 247 mm

LSR, LAS, SCR

24h
8h

Ingram 94682

Stainless steel thermal bottle with double-walled vacuum insulated body and volume-capacity up to 470 mL. Includes tea infuser. Supplied in gift box.

Inox \pm Ø65 x 230 mm | Box: 74 x 235 x 74 mm

LSR, LAS, SCR

24h
8h

Rossi 94069

Stainless steel bottle with lid with an integrated digital thermometer. Double vacuum insulated body with capacity up to 470 mL. Includes infuser for tea. Keeps drinks hot for 8h and cold for 24h. Supplied in a gift box.

Inox \pm Ø65 x 229 mm

SCR, LSR

0,6L

107



Jenson 94237

Borosilicate glass and stainless steel coffee maker. Capacity up to 600 mL. Supplied in a kraft paper gift box.

Ø95 x 170 mm
PDP, LSR



110



Machiato 93895

Set with 2 isothermal glass cups with double body. The cups have capacity up to 350 mL. Supplied in a customisable gift box.

Box: 195 x 125 x 95 mm
PDP, FIR, SCR, SND



110



Espresso 93873

Set with 2 isothermal glass cups with air-insulated double body. The cups have capacity up to 75 mL. Supplied in a customisable gift box.

Box: 133 x 65 x 65 mm
PDP, FIR, SCR, SND



110



Americano 94785

Isothermal glass cup with air-insulated double wall and capacity up to 220 mL. Supplied in a customizable gift box.

Ø80 x 86 mm
PDP, FIR, SCR, SND





Serve your tea with elegance

A teapot made of borosilicate glass with a bamboo lid that allies the sustainability of the materials with the gracefulness of the piece.



Snead 94238

Borosilicate glass teapot with bamboo lid. Includes stainless steel infuser. Capacity up to 750 mL. Supplied in a kraft paper gift box.

Inox
200 x 85 mm

LSR



Arnica 93996

.215



Burdock 93995

.215



Ecuador 250 94766

Double-walled borosilicate glass travel cup with bamboo lid. Glass with a volume-capacity of 250 mL, ideal for cold or hot liquids, with a lid with silicone insulation that facilitates the transport of the glass avoiding splashes. Microwave and dishwasher safe, when lid is removed. Supplied in a paper kraft box.

Ø89 x 91 mm

LSR, FIR, PDP, SCR



Ecuador 350 94767

Double-walled borosilicate glass travel cup with bamboo lid. Cup with a volume-capacity of 350 mL, ideal for cold or hot liquids, with a lid with silicone insulation that facilitates the transport of the glass avoiding splashes. Microwave and dishwasher safe, when lid is removed. Supplied in a paper kraft box.

Ø91 x 119 mm

LSR, DUV, FIR, PDP, SCR





Jasmin 1000 94236

Borosilicate glass bottle with cork lid. Food grade. Capacity up to 1 L. Supplied in a kraft paper gift box.

∓ Ø83 x 215 mm

✓ SCR, LSR



Jasmin 800 94235

Borosilicate glass bottle with cork lid. Food grade. Capacity up to 800 mL. Supplied in a kraft paper gift box.

∓ Ø80 x 190 mm

✓ SCR, LSR



Williams 94669

Borosilicate glass bottle with screw-on lid in PP. Bottle with a matte gradient finish and a silicone handle on the lid. Volume-capacity 470 mL. Supplied in a gift box.

∓ Ø60 x 210 mm

✓ LSR, PDP, SCR

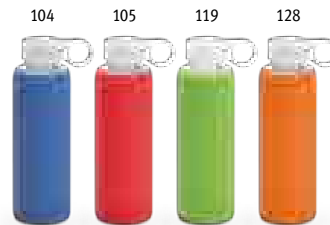

Dhabi 94668

Borosilicate glass bottle with PP screw-on lid. This bottle has a silicone protection. It has a capacity up to 380 mL. Supplied in a gift box.

∓ Ø58 x 191 mm

✓ SCR, DOM



Borosilicate glass

Great strength and durability. Ideal for both hot and cold drinks.

Frosted finish

0,5L



Lillard 94770



Frosted borosilicate glass bottle with bamboo screw-on lid and capacity up to 500 mL. Supplied in a kraft paper gift box.

∅65 x 190 mm

LSR, PDP, SCR



0,6L



Dakar 94699



Borosilicate glass bottle with bamboo screw-on lid and silicone pouch. This bottle has a volume-capacity of 600 mL. Supplied in a gift box.

∅68 x 231 mm

LSR, PDP, SCR





128



Raise 94646

Glass and stainless steel sports bottle with a handle on the screw-on lid for easy transport. Volume-capacity up to 520 mL. Supplied with soft shell pouch.

∅65 x 225 mm
 LSR, PDP, SCR, TRD, TRS



114



Portis Glass 94315

Glass bottle with PP cap. Capacity up to 500 mL. Available in a wide range of colours. Supplied in a gift box.

∅60 x 245 mm
 PDP, SCR



119

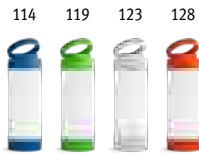

Quintana 94783

Glass sports bottle with screw-on lid made of PP. Contains smartphone holder and handle for easy transport. Volume-capacity up to 390 mL. Supplied in a gift box.

∅61 x 181 mm
 PDP

Ideal for sublimation

This technique is distinguished by the possibility of full colour, while maintaining the quality of a high-quality 360° print.



106

0,5L



Henderson 94264



Double-walled stainless steel sublimation thermal bottle with lid with vacuum system. Capacity up to 500 mL. Keeps drinks hot for 12h and cold for 24h. Supplied in a gift box.

Inox \pm Ø70 x 245 mm

✓ SUB



106

+
0,5L



Amorti 94958



Double-walled stainless steel sublimation bottle with lid with vacuum system. Volume-capacity 510 mL. Supplied in a gift box.

Inox \pm Ø67 x 255 mm

✓ SUB



127

106



Slider 94242



Vacuum insulated double wall stainless steel sublimation travel cup. Includes a clear lid with sliding opening. Capacity up to 380 mL. Supplied in a gift box.

Inox \pm Ø77 x 120 mm

✓ LAS SUB



110

0,5L



Soler 94317



Glass bottle appropriate for sublimation with stainless steel cap. Capacity up to 500 mL. Supplied in a gift box.

Inox \pm Ø65 x 220 mm

✓ SUB



106



Landscape II 94042



Aluminium sublimation sports bottle with carabiner. Volume-capacity 400 mL. Supplied in a gift box.

\pm Ø66 x 176 mm

✓ SUB



106

0,5L



Billy 94957



Aluminium sublimation bottle with stainless steel cap. Volume-capacity 500 mL. Supplied in a gift box.

\pm Ø67 x 205 mm

✓ SUB



Matte finish with glitter



Queta 94250

Aluminium bottle with a matt finish and a bamboo lid.
Capacity up to 550 mL.

∅65 x 197 mm

LAS LSR, SCR, UVC



Rio 94059

Single wall aluminium sports bottle with PP lid and silicone band for easier transport. Capacity up to 660 mL.

∅65 x 228 mm

LAS LSR, SCR

Aluminium bottle

The strength and durability of aluminium allows you to take your favourite bottle wherever you want.



Shawn 94269

Aluminium (90% Recycled) sports bottle with single wall and glossy finish. Lid with flip top opening system. Capacity up to 660 mL.

∓ Ø72 x 198 mm

✓ LAS, SCR, UVC



105

+0.7L



Siderot 94688
 Aluminium sports bottle with carabiner.
 Available in a wide range of colours. Capacity up to 750 mL.
 ∅73 x 247 mm
 LAS, SCR



114



Landscape 94601
 Aluminium sports bottle with carabiner.
 Volume-capacity up to 400 mL.
 ∅66 x 176 mm
 LAS, DUV, LSR, PDP, SCR, UVC

Matte finishing



109

+0.5L



Collina 94246
 Aluminium bottle with matte finish and carabiner for easy transport. Capacity up to 550 mL.
 ∅66 x 216 mm
 LAS, LSR, SCR, UVC





Korver 94631

Single wall sports bottle in aluminium and AS with lid and handle for easy transport. Volume-capacity up to 650 mL.

∅66 x 250 mm

LAS, LSR, PDP, SCR, UVC



Beane 94063

Single wall aluminium sports bottle with stainless steel lid. Capacity up to 500 mL.

∅67 x 205 mm

LAS, LSR, SCR, UVC

Double wall vacuum insulated travel cups



Solberg Tumbler 94327

Stainless steel vacuum insulated double walled travel cup with cork base. Contains a transparent lid with sliding closure and matte finish. Capacity up to 400 mL. Supplied in a kraft box.

± Ø93 x 121 mm

✓ PDP, LSR, SCR



Phelps 94772

Double-walled vacuum insulated stainless steel and PP travel cup. Matte finish and powder coating provides durability and resistance. Capacity of up to 470 mL. Supplied in a gift box.

± Ø90 x 150 mm

✓ LSR



Sliding lid



Ronde 94677

Double-walled stainless steel thermal travel cup with sliding lid. Volume-capacity up to 400 mL. Supplied in a box.

± 88 x 112 mm

✓ LSR, LAS, PDP





Lauda 94276

Double walled mug in recycled stainless steel (90%) with a bamboo lid. Capacity up to 420 mL. Supplied in a Kraft gift box.

∓ Ø88 x 112 mm

Inox **LAS**



Grace 54267

Stainless steel thermal travel cup with vacuum insulated double wall. Ideal for keeping your drinks hot or cold. Capacity up to 540 mL. Supplied in a kraft gift box.

∓ Ø85 x 154 mm

Inox **LSR**



Air-insulated double wall travel cups



24h
8H

Monarda 94681

Double walled stainless steel and PP travel cup. Anti-spill lid and non-slip at the base. The cup has a volume-capacity up to 470 mL. Supplied in a gift box.

∅80 x 198 mm | Box: 82 x 202 x 82 mm

Inox / LSR, LAS, PDP



105

103

105

114

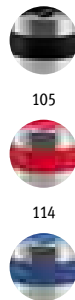

4H
2H

Batum 94625

Stainless steel and PP travel cup with double body. Lid with easy opening and closing system. Volume-capacity 420 mL. Supplied in a gift box.

∅81 x 167 mm

Inox / LSR, LSR, PDP, SCR



4H
2H

Express 94634

Stainless steel and PP travel cup with double air insulated body, lid and non-slip base. Volume-capacity up to 310 mL.

∅73 x 144 mm

Inox / LSR, LSR, PDP, SCR, UVC



114

103



105



114



127



Wings 94614

Stainless steel mug, with a carabiner handle. Volume-capacity 230 mL. Supplied in a gift box.

∅70 x 82 mm

Inox / LSR, LSR, PDP





Novak 94665



Set with stainless steel hip flask with volume-capacity up to 200 mL includes funnel and 4 cups. Cup capacity 20 mL. Supplied in a gift box.



189 x 40 x 168 mm

LSR, SCR, SND, TRD, TRS

107



Muse 94684



Stainless steel pocket bottle with a volume-capacity of 180 mL. Supplied in a gift box.



100 x 110 x 25 mm

LSR, DUV, SND

107



107



Himalayas 94664



Set with 4 stainless steel cups in an PU carrying pouch. Cup capacity is 25 mL. Supplied in a gift box.



Ø44 x 62 mm | Box: 45 x 66 x 45 mm

LSR, PDP



0,5l



110

LANYARD'IN Cup Holder

0.329



MADE IN EUROPE



Kane 94324

Festival cup in PP with single wall and capacity up to 500 mL. Made in Europe.

∅82 x 146 mm

PDP, SCR



Silicone band to make it easier to carry around hot drinks



103



106



114



119



128



Barty 94763

Glass travel cup with volume-capacity up to 330 mL. The cup contains a silicone band to facilitate the transport of hot drinks. Heat transfer can occur. Supplied in a box.

∅80 x 125 mm

PDP, SCR



Reusable cups: a more sustainable choice

0,5l



4H
2H



Cuppari 94041

100% PP double wall air insulated travel cup, 500 mL capacity and flip top lid.

Ø89 x 160 mm

SCR



MADE IN EUROPE



Frappe 94784

Single wall reusable PP cup with PP lid and capacity up to 430 mL. Made in Europe.

Ø87 x 116 mm

SCR



Tonali 450 94322

PP single walled travel cup with PP lid. Capacity up to 450 mL.

Ø90 x 135 mm

PDP

0,7L



Ancer 94687
AS sports bottle with stainless steel bottom. PP and stainless steel lid with insulating silicone. Volume-capacity up to 700 mL.
Inox
∅74 x 265 mm
SCR

↖
Stainless steel base and lid

0,6L



Portis 94630
PP and PS sports bottle. Volume-capacity up to 600 mL.
∅67 x 245 mm
SCR, UVC



0,5L



Conley 94621
PS and PE sports bottle with flexible straw lid (inside). Volume-capacity up to 500 mL.
∅70 x 230 mm
PDP SCR, UVC

↖
Flexible straw inside





Tyson 94329

Sports bottle with internal straw, lid with drinker and handle for easy transport. Big capacity up to 1200 mL.

∅ 95 x 252 mm

PDP

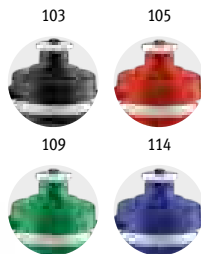

MADE IN EUROPE

Gobert 94764

PEBD sports bottle with push-pull lid. Bottle with volume-capacity up to 680 mL. Made in Europe.

∅76 x 215 mm

SCR



Lowry 94616

HDPE sports bottle with push-pull lid and volume-capacity up to 530 mL.

∅67 x 191 mm

DUV, SCR

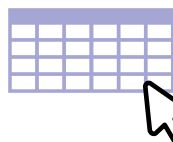

To learn more about other technical features, click here



Hike 94685

Foldable bottle with three layers in PET, PA and PE with volume- capacity of up to 770 mL. The bottle has a PP lid.

158 x 286 x 75 mm

SCR

Travel cups

Foldable for easy transportation



Doming dock



Astrada 94762

Foldable silicone travel cup with PP lid. Contains a handle on the lid. Cup with volume-capacity up to 250 mL.

BPA FREE
 Ø88 x 85 mm

DOM

With a flexible and practical design, the collapsible bottles can accompany you anywhere



Kwill 94612

Foldable PE bottle with push-pull lid. Contains a clear lid and a carabiner. Volume-capacity up to 460 mL.

120 x 265 x 30 mm

SCR

Ceramic and bamboo teapot

Choose products with balanced materials, without sacrificing the refinement you need when serving your hot drinks.



116



Glogg 94255

Ceramic teapot with bamboo lid and handle. Capacity up to 700 mL. Supplied in a kraft paper gift box.

∅164 x 115 mm

LSR



116

133

134



Owens 94253

Set of two ceramic cups with matte finish. Capacity up to 280 mL. Supplied in a kraft paper gift box.

∅74 x 85 mm

PDP, FIR, SCR

With matte finish and shiny finish inside



103

106



Fangio 94251

Ceramic mug with lid and bamboo base. Capacity up to 230 mL. Supplied in a kraft paper gift box. The mug is dishwasher safe and resistant for at least 125 washing cycles (including print) according to EN12875-1.

∅84 x 68 mm

SCR, FIR, LSR





Constellation 94244



Ceramic mug with matte finish and speckled mug exterior. Capacity up to 370 mL. Supplied in a kraft paper gift box. The mug is dishwasher safe and resistant for at least 125 washing cycles (including print) according to EN12875-1.

± 85 x 85 mm
 SCR, FIR



Hydroglaze technique with any Pantone® color

Spraying Pantone® colours, with a matte or glossy finish, on porcelain mugs.

106



MADE IN EUROPE



Panthony Own 94046

Porcelain mug with capacity up to 450 mL. This product is supplied in a box. Not for professional use. Made in Europe.

∅95 x 100 mm | Box: 130 x 101 x 107 mm

➤ PDP, FIR, HDG, SND

103



104



105



106



108



113



114



119



122



128



132



139



144



MADE IN EUROPE



Panthony Mat 94045

Porcelain mug with hydroglaze, matt finish and capacity up to 450 mL. Supplied in a box. Not suitable for professional use. Made in Europe.

∅95 x 100 mm | Box: 130 x 101 x 107 mm

➤ PDP, FIR, SND



103



106



105



103

134



Dhoni 94274

 Ceramic mug with gloss finish. Capacity up to 450 mL. Supplied in a Kraft paper box. The mug is dishwasher safe and resistant for at least 125 washing cycles (including print) according to EN12875-1.

± Ø95 x 100 mm

 **FIR**



106



Dhoni White 94279

 Ceramic mug with gloss finish. Capacity up to 450 mL. Supplied in a Kraft paper box. The mug is dishwasher safe and resistant for at least 125 washing cycles (including print) according to EN12875-1.

± Ø95 x 100 mm

 **FIR**



103

104

105

116



Mighty 94273

 Ceramic mug with a matt finish and cylindrical body. Capacity up to 330 mL. Supplied in a kraft paper gift box. The mug is dishwasher safe and resistant for at least 125 washing cycles (including print) according to EN12875-1.

± Ø80 x 100 mm

 **FIR**

Perfect mugs for sublimation



106



Gotze Sub 94319

Enamel mug suitable for sublimation. Capacity up to 350 mL. Supplied in white box.

∅87 x 80 mm

SUB



110



Carmo 94318

Glass mug suitable for sublimation. Capacity up to 350ml. Supplied in a gift box.

∅80 x 95 mm

SUB



119

103



105



119



124



Mocha 93897

Ceramic mug ideal for sublimation, with capacity up to 350 mL. Supplied in a gift box. The mug is dishwasher safe and resistant for at least 250 washing cycles (including print) according to EN12875-1.

∅82 x 95 mm | Box: 102 x 117 x 88 mm

SUB, PDP



106



Aniseed 93990

Ceramic mug ideal for sublimation with capacity up to 350 mL. Supplied in a gift box. The mug is dishwasher safe and resistant for at least 250 washing cycles (including print) according to EN12875-1.

∅83 x 98 mm | Box: 100 x 118 x 86 mm

SUB, PDP



Rory sub 94275

Ceramic mug with sublimation coating, cork base and gloss finish. The base, which can be removed, is designed to protect the work surface. Capacity up to 410 mL. Dishwasher-safe without the base. Supplied in a kraft paper gift box. The mug is dishwasher safe and resistant for at least 250 washing cycles (including print) according to EN12875-1.

± Ø87 x 110mm

➤ SUB

Don't skimp on refinement when serving your hot drinks



Soffy 94024

Glass mug with a smile on the bottom and capacity up to 230 mL. Supplied in a gift box.

± Ø72 x 89 mm

➤ PDP, FIR, SND

Frosted glass effect



Kenny II 93804

Frosted glass mug with capacity up to 340 mL. Supplied in a gift box.

± Ø80 x 97 mm | Box: 120 x 88 x 102 mm

➤ SCR, FIR, PDP, SND

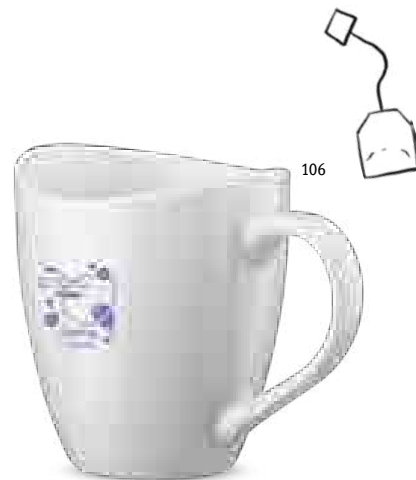

Cinander 93832

Ceramic mug with capacity up to 370 mL. Supplied in a gift box. The mug is dishwasher safe and resistant for at least 125 washing cycles (including print) according to EN12875-1.

∅84 x 103 mm | Box: 120 x 115 x 90 mm

➤ PDP, FIR

Matcha 93888

Porcelain mug with capacity up to 350 mL. Supplied in a gift box. The mug is dishwasher safe and resistant for at least 125 washing cycles (including print) according to EN12875-1.

∅82 x 100 mm | Box: 115 x 120 x 90 mm

➤ PDP, FIR

Lisetta 94047

Ceramic mug with capacity up to 310ml. Supplied in a gift box. The mug is dishwasher safe and resistant for at least 125 washing cycles (including print) according to EN12875-1.

∅88 x 96 mm | Box: 112 x 89 x 102 mm

➤ PDP, FIR

With neon finish



Lynch 93886

Ceramic mug with neon matte finish and capacity up to 350 mL. The exterior finish of this mug recreates the effect of the slate and allows you to write on it using chalk (not included). Supplied in a gift box.

∅83 x 97 mm | Box: 102 x 117 x 88 mm

➤ PDP, FIR, SCR

Colby 93837

Ceramic mug with capacity up to 320 mL. Supplied in a gift box. The mug is dishwasher safe and resistant for at least 125 washing cycles (including print) according to EN12875-1.

∅90 x 104 mm

➤ PDP, FIR



Comander 93833

Ceramic mug with capacity up to 370 mL. Supplied in a gift box. The mug is dishwasher safe and resistant for at least 125 washing cycles (including print) according to EN12875-1.

∅90 x 85 mm | Box: 92 x 120 x 94 mm

➤ PDP, FIR



Avoine 93834

Ceramic mug with capacity up to 370 mL. Supplied in a gift box. The mug is dishwasher safe and resistant for at least 125 washing cycles (including print) according to EN12875-1.

∅90 x 85 mm | Box: 111 x 115 x 87 mm

➤ PDP, FIR



Vernon 93836

Ceramic mug with capacity up to 360 mL. Supplied in a gift box. The mug is dishwasher safe and resistant for at least 125 washing cycles (including print) according to EN12875-1.

∅88 x 84 mm | Box: 112 x 94 x 91 mm

➤ PDP, FIR, SCR



Vernon White 94673

Ceramic mug with volume-capacity of 360 mL. Supplied in a gift box. The mug is dishwasher safe and resistant for at least 125 washing cycles (including print) according to EN12875-1.

∅88 x 84 mm | Box: 112 x 94 x 91 mm

➤ SCR, FIR, PDP



Slate finish with
chalk included



104



106



106



106



106

Barine 93887

Ceramic mug with a capacity up to 350 mL. Supplied in a box. The mug is dishwasher safe and resistant for at least 125 washing cycles (including print) according to EN12875-1.

∅82 x 97 mm | Box: 102 x 117 x 88 mm

PDP, FIR, SCR

Curcum 93937

Ceramic mug with a capacity of up to 350 mL. Supplied in a box. The mug is dishwasher safe and resistant for at least 125 washing cycles (including print) according to EN12875-1.

∅83 x 98 mm | Box: 100 x 118 x 86 mm

PDP, FIR, SCR

Chalkie 93957

Ceramic mug with capacity up to 360 mL. The exterior finish of this mug recreates the effect of the slate and allows you to write on it using chalk (included). Supplied in a box.

∅81 x 96 mm | Box: 102 x 118 x 88 mm

PDP, SCR

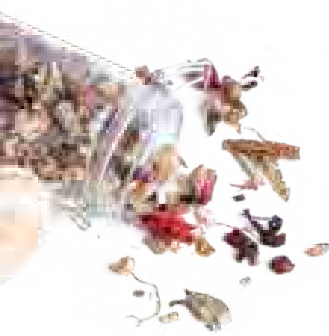

Stainless steel
strainer



106



Cole 93805

2 in 1 ceramic tea set. The set includes a teapot with stainless steel strainer (430 mL) and a mug with capacity up to 260 mL. Supplied in a gift box.

∅113 x 140 mm

LSR, FIR, PDP



HOME



Relax and set the mood with candles and air fresheners with relaxing fragrances

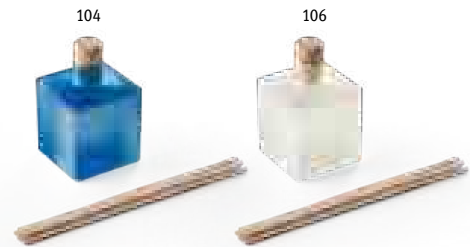
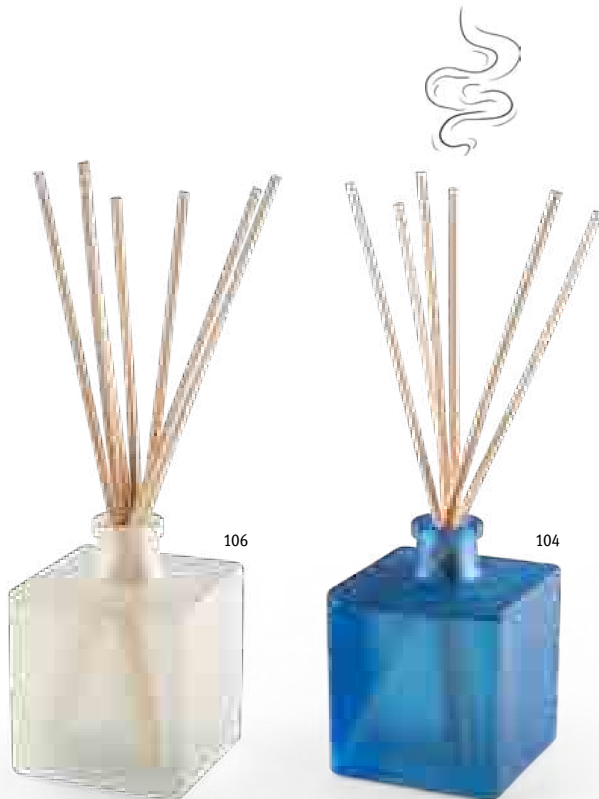

MADE IN EUROPE



Yeun 95067

Scent diffuser in a glass bottle with a lid. The diffuser rods are made of rattan - a natural fibre perfect for diffusing fragrances. Quantity up to 100 mL. Made in Europe. Supplied in an individual gift box.
Colour 104 - Red fruits
Colour 106 - White musk

∅ 55 x 55 x 90 mm | Box: 60 x 63 x 197 mm

STI

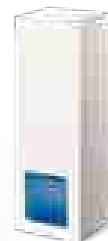

MADE IN EUROPE



Duval 95075

Scented candle in a glass holder with a cork lid. Vegan vegetable wax. The natural materials and strong fragrance help make your home a more relaxing environment. Quantity up to 180 g. Made in Europe. Supplied in an individual gift box.

Colour 104 - Red fruits
Colour 106 - White Musk

∅ 75 x 95 mm | Box: 78 x 78 x 100 mm

STI, LSR, SCR





105

Sweet 95817

Heart shaped candle and glass base. Gift box included.

Box: 93 x 93 x 25 mm

STI



110



MADE IN EUROPE

Zen 80 95077

Aromatic candle in a glass holder with a cork lid. The fragrance helps make your home a more relaxing environment. Quantity up to 80 g. Made in Europe. Supplied in an individual gift box. Colour 110 - Vanilla

Box: 59 x 59 x 75 mm

LSR, SCR



110



MADE IN EUROPE

Zen 180 95078

Aromatic candle in a glass cup with a cork lid. The fragrance helps make your home a more relaxing environment. Quantity up to 180 g. Made in Europe. Supplied in an individual gift box. Colour 110 - Vanilla

Box: 78 x 78 x 100 mm

LSR, SCR



Cosy environment

Enjoy moments at home to relax.



Smooth 99044

100% acrylic blanket (270 g/m²) with soft touch. Supplied with satin ribbon and cardboard for customisation. Products supplied separately.

1300 x 1500 mm

SCR, EDB, ETD

Anti-pilling treatment



Dyleaf 99075

Polar fleece blanket (240 g/m²) with velvety finish and anti-pilling treatment. The blanket includes a satin ribbon and card for customisation. Products supplied separately.

1500 x 1200 mm | Cardboard: 160 x 130 mm

SCR, EDB, ETD



Sulena 99051

Fleece blanket (180 g/m²). Available in a wide range of colours.

1450 x 950 mm

TRS, EDB, ETD, TRD

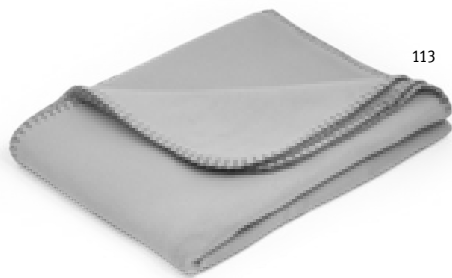

113

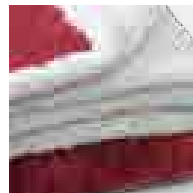

Reversible blanket

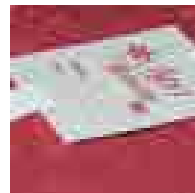

Customizable card

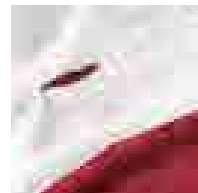

Zipper



104



113



Galliot 99079

Polar blanket (180 g/m²) in PET (100% rPET) with bag in PET (100% rPET) 210D.

± 1500 x 1200 mm

✓ TRS, EDB, ETD, TRD



113



115



131

Heiden 99078

Reversible satin polar fleece blanket 190 g/m² with sherpa lining (225 g/m²), for greater comfort. A zip closure is included in the lining to allow easy printing. It comes with a satin ribbon with a self-adhesive hook and loop fastener and a customisable card. Products are supplied separately.

± Blanket: 1500 x 1200 mm | Satin Ribbon: 750 x 40 mm | Card: 160 x 130 mm

✓ SCR, EDB, ETD



150

Miguel 98004

Domino game in wooden box with lid. Black pieces with embossing details in white.

⌄ 146 x 50 x 30 mm

➤ LSR, SCR



150

Mika 98006

Traditional mikado game, supplied in a wooden box with a sliding lid.

⌄ 193 x 45 x 26 mm

➤ LSR, SCR

Rigid box



Crosses

98097

📦 .269

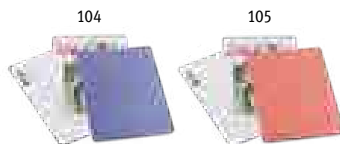

104

105

Johan 98081

Deck of 54 cards in laminated paper. Supplied in a rigid box.

⌄ 100 x 70 x 20 mm

➤ STI, PDP

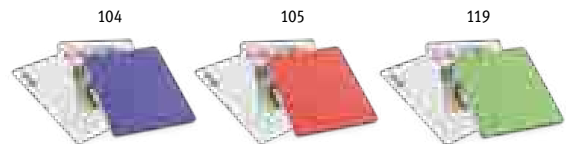
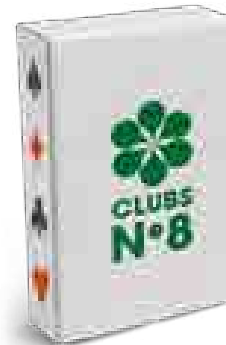

104

105

119

Cartes 98080

Deck of 54 cards in laminated paper. Supplied in a paper box.

⌄ 89 x 59 x 17 mm

➤ SCR, DUV, PDP

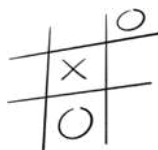

150

Playtime 98001

Family game set: 4 in 1. This wooden box includes: domino, mikado, a deck of cards and dice.

± 190 x 138 x 31 mm

LSR SCR



150



Flik 98491

Wooden game with 54 pieces. Supplied in a cardboard box with a customizable cotton bag.

± 55 x 55 x 185 mm

TRS TRD





160



Woods 93830



Bamboo cheese board with 2 bamboo and stainless steel accessories. Supplied in a kraft paper gift box.



310 x 180 x 15 mm | Box: 316 x 186 x 25 mm

LSR



160



Cappero 94028



Set with bamboo cutting board and small cheese knife. Supplied in kraft paper gift box.



200 x 143 x 10 mm | Box: 205 x 150 x 32 mm

LSR



160



Banon 93880

Bamboo serving board with a cutout for easy handling, making it easy to hang the board. Ideal for serving food.

300 x 200 x 9 mm

LSR



160



Capers 93966

Bamboo serving board. The handle allows you to hang the board. Ideal for serving food.

200 x 143 x 9 mm

LSR



160



Mustard 93861



Bamboo tray, suitable for serving food. Supplied in a kraft paper gift box.

255 x 130 x 18 mm | Box: 260 x 134 x 26 mm

LSR



160



Sesame 93831

Bamboo tray ideal for serving snacks with string for hanging. Supplied in cardboard sleeve.

420 x 134 x 10 mm | Sleeve: 260 x 135 x 10 mm

LSR



Bamboo boards: different sizes and shapes in a sturdy, quality material



Caraway Round 94259

Large bamboo serving board with handle, very versatile. Ideal for pizza. Supplied in a kraft paper gift box.

± 310 x 408 x 12 mm

LSR



Caraway 94260

Large bamboo serving board with handle, very versatile. Supplied with a kraft gift box.

± 240 x 450 x 12 mm

LSR



Caraway Long 94258

Large bamboo serving board with handle, very versatile. Supplied in kraft paper gift box.

± 155 x 600 x 12 mm

LSR

Choose excellent products for your barbecue

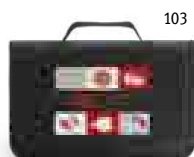

103



Flare 54142

Five-piece wooden and stainless steel barbecue set with bamboo board. Kit with 5 utensils and board, supplied with a 210D hard case.

Tray: 300 x 200 x 12 mm | Bag: 350 x 230 x 40 mm

LSR, TRD, TRS



160



Kabsa 53844

Barbecue set supplied in a bamboo case. Contains 6 stainless steel and bamboo pieces: chef's knife, medium knife, Japanese knife, tongs, fork and knife sharpener.

Case: 160 x 455 x 65 mm

LSR, SCR



103



Soares 93998

Barbecue set with 3 stainless steel pieces: tong, fork and spatula. Supplied in a non-woven bag with handles.

Bag: 405 x 120 x 25 mm

LSR, TRD, TRS



160



Salsa 54139

Two-piece barbecue set. Includes stainless steel steak fork and knife with bamboo handles. Supplied in a kraft paper box.

Box: 340 x 115 x 25 mm

LSR, SCR





160



Passard 94321



Bread board in bamboo with stainless steel knife included. The grid detaches for easy cleaning. Supplied in kraft paper gift box.



± 350 x 250 x 40 mm

LSR, SCR



150

Monco 92836

100% cotton bread bag (100 g/m²) with drawstring for closure.

± 220 x 560 mm

TRs, EDB, ETD, TRD



160



Poke 54143



Barbecue set supplied in a kraft box. Contains a bamboo board and 2 utensils in stainless steel and bamboo: chef's knife and fork.



± Board: 200 x 300 x 12 mm | Box: 360 x 210 x 40 mm

LSR, PDP, SCR, TRD, TRS



160



Marjoram 94261



Bamboo cutting board. Supplied with a kraft gift box.



± 400 x 300 x 15 mm

LSR





Salvy 93969

Set of 2 bamboo cutlery. Ideal to serve your salad.

± 300 x 60 mm

LSR

160



Shandy 94320

Folding bamboo pot stand. Supplied in kraft paper gift box.

± Closed: 215 x 40 x 14 mm |

± Open: 180 x 150 x 14 mm

LSR, PDP, SCR



Pepper 93968

Square bamboo salad bowl. Add the Salvy set of 2 bamboo salad cutlery.

± 214 x 214 x 70 mm

LSR

160



Charles 93875

Glass cruet containing two compartments with capacity up to 50 mL and up to 250 mL. This cruet contains two cork stoppers. Supplied in a cork box.

± Ø57 x 155 mm | Box: 75 x 175 x 75 mm

PDP, SCR

110



Smartpepper 93989

Stainless steel spice mill. The glass container inside the mill allows you to store the spice and use as needed.

± Ø27 x 153 mm

LSR, LAS



127

Up to **1** hour



Montigny 97389

ABS kitchen timer with rubber finish.

± Ø59 x 45 mm

SCR

103



The perfect kit for your sushi



Morimoto 94314

Sushi set in bamboo with a mat, 2 pairs of chopsticks, 1 spoon and 1 knife. Supplied in a kraft paper gift box.

Box: 245 x 100 x 33 mm

LSR, PDP, SCR



Weighing capacity up to **5 kg**



Heisenberg 94312

Bamboo digital kitchen scale with Tare function included. Weighing capacity up to 5 kg. Includes two AAA batteries. Supplied in kraft box.

145 x 200 x 17 mm

DUV, LSR, SCR

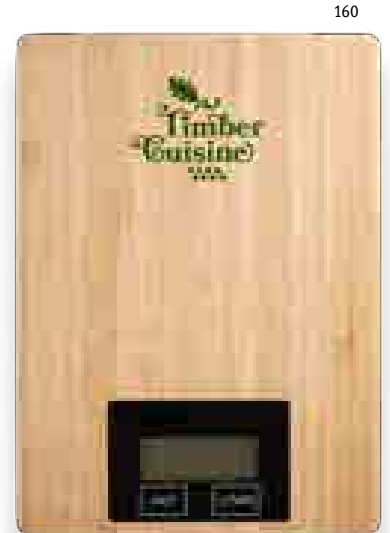

The balance between cork and glass

A simple design that allows you to create unique and sophisticated environments.



Jasmin 1000 94236

Borosilicate glass bottle with cork lid. Food grade. Capacity up to 1 L. Supplied in a kraft paper gift box.

∅83 x 215 mm

SCR, LSR



Jasmin 800 94235

Borosilicate glass bottle with cork lid. Food grade. Capacity up to 800 mL. Supplied in a kraft paper gift box.

∅80 x 190 mm

SCR, LSR

1L

160



0,8L

160





0,7L

160

+ 0,3L

160



Spice 380 94099



Borosilicate glass bottle with cork lid. Capacity up to 380 mL. Supplied in a kraft box.

∅95 x 60 mm

LSR



Spice 700 94079



Borosilicate glass bottle with cork lid. Capacity up to 700 mL. Supplied in a kraft box.

∅95 x 110 mm

LSR

Enjoy the oldest european tea

Offering Gorreana is offering history with aroma.

Founded in 1883 and located in Azores, the Gorreana tea factory is the oldest in Europe. The same family has been managing the planting area of 45 hectares for about 5 generations.

Gorreana teas represent a union of taste, health and ecology. Gorreana teas have worldwide recognition and are ranked as some of the best and purest teas in the world.



160



Burdock 93995



Bamboo tea box with 2 compartments and magnet closure. This tea box includes 20 tea bags of "Gorreana" Azorean tea (10 bags of black tea and 10 bags of green tea). Supplied in a kraft paper gift box.

160 x 87 x 78 mm | Kraft box: 166 x 91 x 87 mm

LSR, SCR



160



Arnica 93996



Bamboo tea box with 4 compartments and magnet closure. This tea box includes 40 tea bags of "Gorreana" Azores tea (20 bags of black tea and 20 bags of green tea). Supplied in a kraft paper gift box.

160 x 160 x 78 mm | Kraft box: 166 x 166 x 85 mm

LSR, SCR

Silicone sealant

1 liter



160



Portobello 94781

Hermetic box in borosilicate glass and bamboo lid with silicone sealant. Suitable for microwave and dishwasher use, when lid is removed. Supplied in a kraft paper gift box.

196 x 145 x 64 mm | Box: 202 x 150 x 66 mm

LSR, PDP



0,8 liter



160

105



103

105

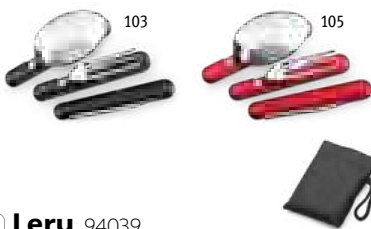

Shino 94025

Stainless steel lunch box with bamboo lid and an elastic band for safe carrying. Capacity up to 800 mL. Supplied in kraft box.

165 x 115 x 52 mm

LSR, SCR



Lery 94039

Cutlery set with 3 foldable pieces: a stainless steel spoon, fork and knife. This set is supplied in a 600D pouch.

Folded: 92 mm | Open: 165 mm | Bag: 80 x 110 mm

LSR, PDP, TRD, TRS



160



Suya 94077

Wooden cutlery set consisting of: fork, knife and spoon. Includes kraft napkin. Supplied in a kraft paper pouch.

62 x 216 mm

STI



Double wall vacuum insulated



103

+
0,5L



127

+
0,7L



Gimlet 94245

Stainless steel vacuum-insulated double-walled food thermos. Includes a foldable spoon that is stored inside the lid. It has a capacity of up to 550 mL. Supplied in kraft box.

∅95 x 154 mm
 LAS, LSR, SCR



Allspice 94277

Robust hermetic box made of 90% stainless steel (90% recycled) with side safety buckles. Capacity up to 750 mL. Supplied in a Kraft paper gift box.

170 x 119 x 57 mm
 LSR

2 compartments

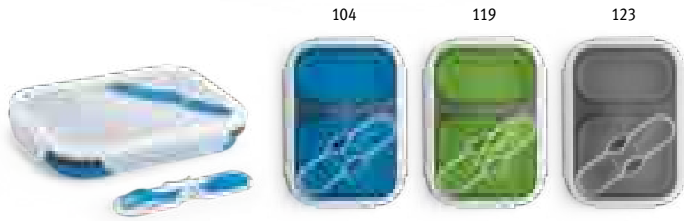

Dill 93848

Retractable hermetic box in silicone and PP with 2 compartments and capacities up to 480 mL and 760 mL. On top of the lid there is a space to store one piece of tableware (included), with a 2 in 1 function, fork and spoon. The box is suitable for microwave use, with the lid having to be removed.

212 x 153 x 73 mm | Folded: 212 x 153 x 38 mm

PDP

105

+ 0,6L



2 in 1 cutlery, fork and spoon



Saffron 93847

Retractable hermetic box in silicone and PP with a compartment with capacity up to 640 mL. On top of the lid there is a space to store one piece of tableware (included), with a 2 in 1 function, fork and spoon. The box is suitable for microwave use, with the lid having to be removed.

160 x 110 x 66 mm | Folded: 160 x 110 x 40 mm

PDP

With protective cover

With bottle opener

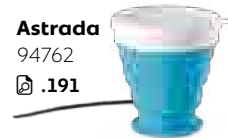

Astrada
94762
.191

Mikus 93872

Stainless steel and PP knife with protective cover.

205 x 31 x 13 mm

LSR, PDP

Tokev 93870

Pizza cutter with bottle opener.

132 x 63 x 8 mm

PDP, DUV





103



103



106

Pyrus 94265

PP hermetic box with a capacity of up to 1000 mL. The lid has a compartment for cutlery (included). The box is suitable for microwave, the lid needs to be removed. Not recommended for liquids.

210 x 145 x 80 mm

PDP, DUV



104

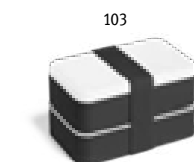

103



104

Bocuse 93853

PP and PS lunch box with 2 compartments (680 mL each) and 1 removable divider. Includes 3 pieces of cutlery: fork, knife and spoon. Closes with an elastic band and is suitable for microwave (remove lid).

180 x 100 x 100 mm

PDP, SCR

Silicone carrying handle



106

103



Samoura 93851

PP double-walled thermal container. With silicone carrying handle, ideal for meals. Capacity up to 380 mL.

90 x 105 mm

PDP

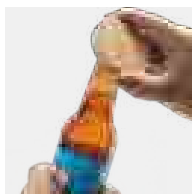

Amchur 94573

Bamboo coaster with bottle opener and magnet.

∓ Ø65 x 11 mm

✂ LSR, PDP, SCR

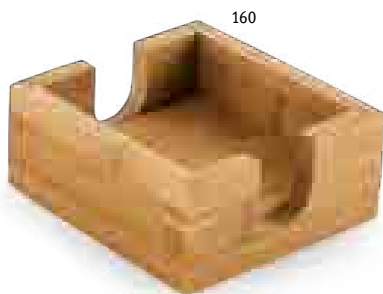

Gauthier 93967

Set with 4 bamboo coasters. Supplied in a kraft paper gift box.

∓ 115 x 115 x 35 mm | Coaster: 100 x 100 x 6 mm |

Box: 119 x 121 x 56 mm

✂ LSR, DUV, SCR



Pisani 93828

Round cork coaster. Ideal for placing glasses on the table.

∓ Ø100 x 5 mm

✂ SCR, LSR, TRD, TRS

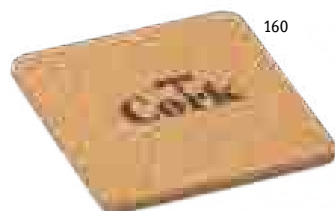

Garcia 93827

Square cork coaster with round corners.

∓ 100 x 100 x 5 mm

✂ SCR, LSR, TRD, TRS





Inox **Glacier** 94252

Set of four stainless steel reusable cubes. Supplied in PP box with sleeve paper protection.

± 60 x 60 x 30 mm

➤ PDP, DOM, SCR



Inox **Bramble** 94043

6-piece stainless steel cocktail set: a shaker (600 + 450 mL), a measuring cup (30 mL), a spoon, a pestle and a strainer. Includes a non-woven pouch. Supplied in a gift box.

± Box: 98 x 98 x 290 mm

➤ LAS, TRD, TRS

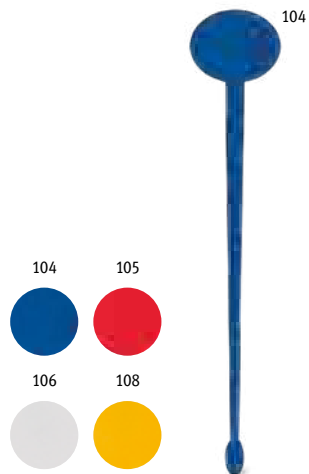

104 105

106 108

MADE IN EUROPE

Inox **Buchanio** 93971

PS cocktail stirrer. Made in Europe.

± 35 x 180 mm

➤ SCR



Inox **Lamone** 94098

Set with 10 disposable kraft paper straws. Supplied in a kraft paper box.

± Straw: Ø6 x 196 mm | Case: 33 x 200 x 14 mm

➤ SCR



Inox **Cocktail** 94097

Reusable stainless steel straw kit and cleaning brush. Supplied in a non-woven pouch (80 g/m²) with drawstring closure.

± Straw: Ø6 x 215 mm | Pouch: 60 x 265 mm

➤ LSR, TRD, TRS

The indispensable accessories for enjoying your wine



 **Moreto** 94119

Wine set with 4 pieces in wood and metal: corkscrew with sommelier knife, drip stopper, pourer with lid and stopper. Supplied in a cork gift box.

∅144 x 42 mm

LSR, PDP, SCR, TRD, TRS



  **Cabernet** 94190

Bamboo and zinc wine set. This set includes: corkscrew with sommelier knife, thermometer, stopper and drip stopper.

147 x 167 x 54 mm

LSR, DUV, PDP, SCR



  **Syrah** 94189

Bamboo and zinc wine set. This set includes: corkscrew with sommelier knife, drip stopper, pourer with lid and stopper.

363 x 112 x 119 mm

LSR, PDP, SCR



 **Barrel** 94191

Zinc wine set. Includes corkscrew with sommelier knife and stopper. Supplied in a gift box.

103 x 133 x 28 mm

LSR, SCR



 **Viognier** 94278
 Wine stopper with vacuum pump system for wine bottles. Ideal for replacing the traditional cork stopper. Supplied in a gift box.
 ⚡ 30 x 90 mm
 🏠 PDP

 **Merlot** 94249
 Electric corkscrew. AA batteries included. Supplied in gift a box.
 ⚡ Corkscrew: Ø48 x 230 mm |
 Box: 54 x 54 x 250 mm
 🏠 PDP

 **Winery** 94248
 ABS and TPE electric corkscrew set and accessories. Includes foil cutter, vacuum stopper and drip stopper. Batteries included. Supplied with gift box.
 ⚡ Corkscrew: 45 x 227 mm | Box: 241 x 90 x 54 mm
 🏠 PDP



Macabeu 94193
 This 190T cooling sleeve should be refrigerated and not frozen
 ⚡ 316 x 228 mm
 🏠 TRS TRD



Ideal for wider bottles

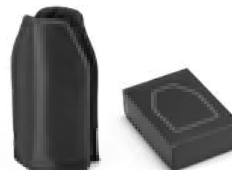

 **Blend** 94247
 Nylon cooler sleeve with elastic on the sides. Supplied in a gift box.
 ⚡ 160 x 230 mm
 🏠 TRS TRD





Barley 94118
Aluminium bottle opener with hole for hanging.
⌄ 39 x 83 x 4 mm
✔ LSR, SCR

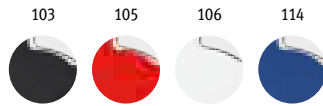

Malte 94115
Bottle opener with magnet. Available in a wide range of colours.
⌄ 50 x 105 x 5 mm
✔ PDP, DUV, SCR



Funfaye 94116
Coaster with bottle opener and non-slip sponge on the base.
⌄ 82 x 82 x 4 mm
✔ PDP, DUV, SCR

With ball pen holder



B6 Truffle 92061
Bill holder in PU with pen holder (pen not included). Ideal for the hospitality sector.
⌄ 125 x 181 x 7 mm
✔ SCR, HTS





Holz 94134

Metal bottle opener with wooden handle.

☿ 40 x 150 x 17 mm

🔪 LSR, PDP, SCR

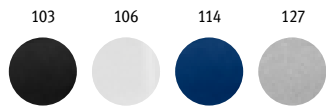

Inox **Malbec** 94117

Metal and PP corkscrew with bottle opener, sommelier knife and stainless steel spiral.

☿ 121 x 20 x 12 mm

🔪 LSR, PDP



Carin 94114

Wooden corkscrew with decapsulator and sommelier knife.

☿ 109 x 25 x 8 mm

🔪 LSR, PDP



Baird 92844

Non-woven bag for 1 bottle (80 g/m²) with handles.

☿ 100 x 330 x 100 mm

🔪 TRS, TRD



Jerome 92883

100% cotton bottle bag (180 g/m²) with drawstring closure, also in cotton.

☿ 150 x 340 mm

🔪 TRS, TRD



❄️ **Colombia** 94194

PVC cooler bag for 1 bottle with 35 cm handles.

☿ 100 x 250 x 100 mm

🔪 SCR



104

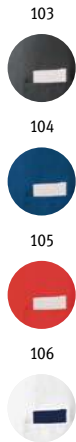

Chives 99822

Cotton (10%) and polyester apron (150 g/m²) with drawstrings and 2 front pockets. Available in a wide range of colors.

± 650 x 900 mm | Inner pocket: 80 x 140 mm | Outer pocket: 250 x 160 mm

✂️ TXP, EDB, ETD, TRD, TRS



119

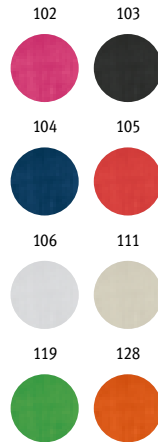

Curry 99811

Apron in cotton (20%) and polyester (180 g/m²) in various colors and with drawstrings.

± 650 x 900 mm

✂️ TRS, EDB, ETD, TRD



128

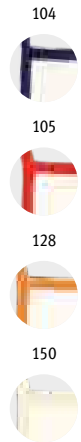

Chilli 99800

Apron in soft 100% cotton material in raw color with colorful details. Apron with 1 front pocket and drawstrings. Available in a wide range of colors.

± 600 x 900 mm | Pocket: 250 x 200 mm

✂️ TXP, EDB, ETD, TRD, TRS



105

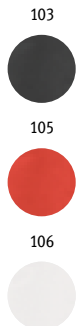

Celery 99832

Non-woven apron (80 g/m²) with 1 front pocket and strings. Available in a wide range of colors.

± 490 x 685 mm | Pocket: 230 x 175 mm

✂️ TXP, TRD, TRS



103

Naeker 99824

Cotton (10%) and polyester bar apron (145 g/m²), with 2 pockets.

± 960 x 800 mm | Pocket: 145 x 200 mm

✂️ TXP, EDB, ETD, TRD, TRS



103

Rosemary 99831

Cotton (10%) and polyester bar apron (145 g/m²), with 2 pockets and adjustable straps.

± 900 x 480 mm | Pocket: 200 x 195 mm

✂️ TXP, EDB, ETD, TRD, TRS



Vesper 99816

100% cotton canvas apron (300 g/m²) with metal details. With 3 multifunctional pockets and a side strip (to hang a kitchen towel). Easily adjustable neck strap. Supplied with a kraft gift box made from FSC™ certified material and other controlled materials.

± 680 x 900 mm

➤ TRS, EDB, ETD, TRD, TXP

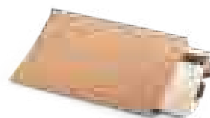
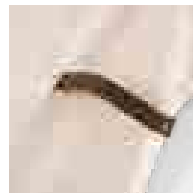

Holm 99815

100% cotton canvas apron (320 g/m²) with metal details. With 3 multifunctional pockets and a side strip (to hang a kitchen towel). Easily adjustable neck strap. Supplied with a gift box in kraft made from FSC™ certified material and other controlled materials.

± 680 x 900 mm

➤ TRS, EDB, ETD, TRD, TXP



Chicory 99835

Cotton canvas multi-purpose apron (260 g/m²) with 3 front pockets and a ribbon waist tie.

± 580 x 375 mm

➤ TXP, EDB, ETD, TRD, TRS



Rickey 94575

Kitchen glove made from 60% recycled cotton.

± 150 x 300 mm

➤ TRS, TRD



Zimbrow 99812

Apron (140 g/m²) with cotton (60% recycled) and front pocket.

± 590 x 900 mm | Pocket: 250 x 200 mm

➤ TXP, EDB, ETD, TRD, TRS



MADE IN EUROPE



MADE IN EUROPE

Boxie Clear S 94943

Plywood box with sliding lid, in the same material. Size S.

Interior: 200 x 160 x 49 mm |
Outside: 220 x 180 x 60 mm

LSR



MADE IN EUROPE

Boxie Clear M 94944

Plywood box with sliding lid, in the same material. Size M.

Interior: 290 x 165 x 97 mm |
Outside: 308 x 182 x 110 mm

LSR

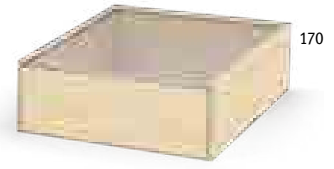

MADE IN EUROPE

Boxie Clear L 94945

Plywood box with sliding lid, in the same material. Size L.

Interior: 329 x 290 x 96 mm |
Outside: 348 x 309 x 110 mm

LSR



MADE IN EUROPE

Boxie Wood S 94940

Plywood box with sliding lid, in the same material. Size S.

Interior: 220 x 180 x 59 mm |
Outside: 239 x 200 x 73 mm

LSR



MADE IN EUROPE

Boxie Wood M 94941

Plywood box with sliding lid, in the same material. Size M.

Interior: 290 x 164 x 104 mm |
Outside: 309 x 189 x 118 mm

LSR

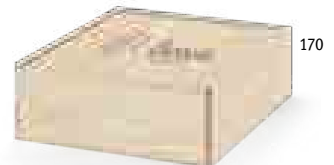

MADE IN EUROPE

Boxie Wood L 94942

Plywood box with sliding lid, in the same material. Size L.

Interior: 330 x 290 x 97 mm |
Outside: 348 x 308 x 111 mm

LSR



MADE IN EUROPE

Boxie Can S 94980

Cylindrical FSC™ cardboard box with metal lid and base. This product is made from FSC™ certified material and other controlled materials.

Interior: 165 x 99 mm | Interior: 160 x 99 mm

PDP, LSR, SCR, STI



MADE IN EUROPE

Boxie Can M 94986

Cylindrical FSC™ cardboard box with metal lid and base. This product is made from FSC™ certified material and other controlled materials.

Interior: 240 x 99 mm | Interior: 235 x 99 mm

PDP, LSR, SCR, STI



MADE IN EUROPE

Boxie Can L 94992

Cylindrical FSC™ cardboard box with metal lid and base. This product is made from FSC™ certified material and other controlled materials.

Interior: 330 x 99 mm | Interior: 325 x 99 mm

PDP, LSR, SCR, STI

PERSONAL & TRAVEL



Ach. Brito

An alliance between tradition and modernity

Ach.Brito is one of the oldest and most cherished companies in Portugal. Founded in the city of Porto in 1918, this century-old soap and perfume company stands out for its tradition and elegance. Its longevity is essentially due to four important pillars: its historical legacy, the beauty of its packaging, its experience in soap production and the quality of its products.

Present in more than 50 countries, Ach.Brito occupies a transversal position in the market presenting products and brands for many different market segments. From the oldest to the most modern collections, they offer a compilation of products to meet all your preferences and needs. Combining historical legacy with guaranteed competitiveness, we are pleased to have joined a European brand that, given its longevity, offers unparalleled quality and totally distinctive products, with production entirely Made in Europe.



Patti

The success of this famous soap is due to a quality formula based on vegetable soap and invigorating, unmistakable fragrances such as rose, vanilla, lavender, bergamot and patchouli. Ideal for daily skin care, making your skin softer and smoother. After 90 years since its launch, Patti soap is considered a best seller and a favourite with consumers. Capacity up to 160 g. Environmentally friendly product.



Patti 15 g 35600

± 57 x 10 x 34 mm
 / STI



Patti 90 g 35601

± 80 x 50 x 22 mm
 / STI



Patti 160 g 35602

± 90 x 60 x 30 mm
 / STI

Lavanda

Soap made with a vegetable soap base and Lavender fragrance, with a soft texture that leaves the skin perfumed. Traditionally produced in Portugal. Capacity 125 g. Classic design packaging that retains the original design, with its green background decorated with small graphics representing lavender flowers.



Lavanda 20 g 35610

± 59 x 34 x 10 mm
 / STI



Lavanda 125 g 35611

± 90 x 53 x 20 mm
 / STI

Musgo

Created in 1936 for the wealthier classes, the Musgo collection is identified by the crown on its packaging, which symbolizes Portuguese aristocracy and masculine fragrance.



Musgo I 35612

Men's fragrance soap (160g).
 ± 90 x 60 x 30 mm
 / STI

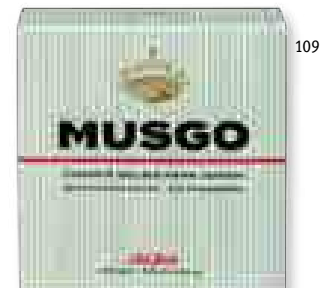

Musgo II 35613

Men's fragrance shampoo (150g).
 ± 67 x 70 x 31 mm
 / STI

MADE IN EUROPE



103

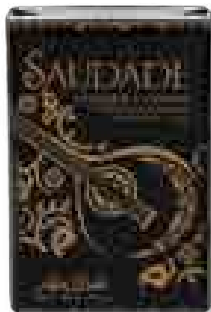

105



106

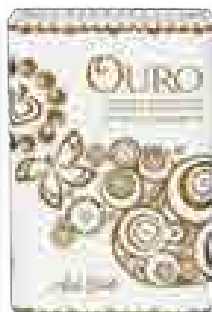

102

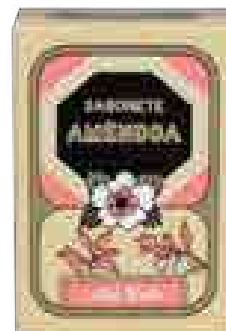

109



108



109

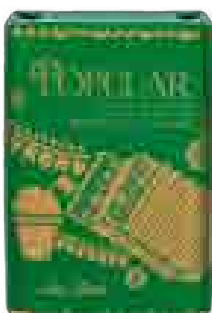

114



113

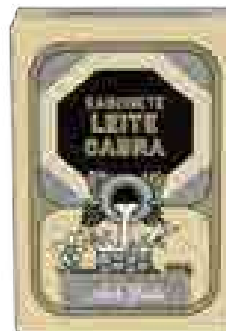

115

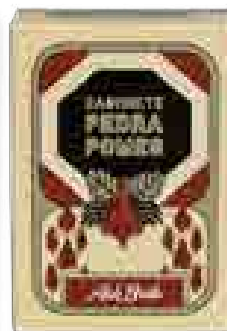

Símbolos Lusitanos 35603

A Lusitanian collection that harks back to Portuguese traditionalism, with packaging alluding to different national elements. Soaps based on vegetable soap and enriched with olive oil. Produced traditionally in Portugal and is suitable for all skin types. Capacity up to 75g. Environmentally friendly product.

Colour 103: Saudade Soap - Lavender, jasmine, tarragon, bergamot, patchouli and amber fragrance

Colour 105: Galo Soap - Thyme and orange fragrance with hints of sunflower and olive wood

Colour 106: Ouro Soap - Fragrance of cistus and chamomile with notes of cedarwood and vetiver

Colour 108: Azulejo Soap - Honey and rosemary fragrance with hints of fresh mint and lemon leaves

Colour 109: Popular Soap - Basil and pine fragrance with woody notes of cypress

Colour 114: Mar Soap - Fragrance of seaweed and sea breezes with hints of fleur de sel and water lily

☿ 55 x 80 x 20 mm

STI

Cuidados Essenciais 35606

Set of soaps belonging to the essential care line, based on vegetable soap to care for your skin, each one designed for a different purpose. Produced traditionally in Portugal and is suitable for all skin types. Capacity up to 90g. Environmentally friendly product.

Colour 102: Soap to retain water in the skin - Almond and Oatmeal

Colour 109: Moisturizing Soap - Aloe Vera and wild mint

Colour 113: Moisturizing Soap - Goat's Milk

Colour 115: Exfoliating Soap - Pumice Stone Powder

☿ 57 x 83 x 24 mm

STI

Royal Jungle 35609

Set of soaps belonging to the Royal Jungle collection based on vegetable soap and elegant fragrances enriched with green clay - characterised by its purifying properties. When used, it creates a creamy lather that leaves the skin clean, purified and lightly scented. Produced traditionally in Portugal and suitable for all skin types. Capacity up to 160 g. Environmentally friendly product.

Colour 112: Bird line

Colour 123: Safari line

90 x 60 x 30 mm

STI

112



123



Tropical Blossom 35614

Set of soaps belonging to the Tropical Blossom collection based on vegetable soap and elegant fragrances enriched with olive oil - characteristic for its moisturizing properties. When used, it creates a creamy lather that leaves the skin clean, purified and lightly scented. Traditionally produced in Portugal and suitable for all skin types. Capacity up to 160 g. Environmentally friendly product.

Colour 128: Fruit line

Colour 129: Leaf line

90 x 60 x 30 mm

STI

128

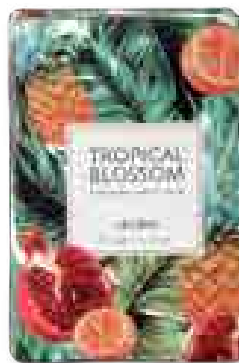

129



101



118



Frutados I 35604

Soap based on vegetable soap and enriched with coconut oil. When used this soap provides a creamy lather leaving the skin clean, soft and moisturized. Capacity up to 75 g. Environmentally friendly soap traditionally produced in Portugal.

A collection that aims to highlight vibrant fruity aromas:

Colour 101: Coconut-scented soap

Colour 118: Pear-scented soap

55 x 80 x 20 mm

STI

108

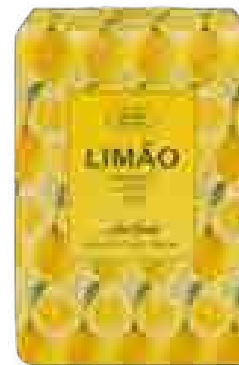

115

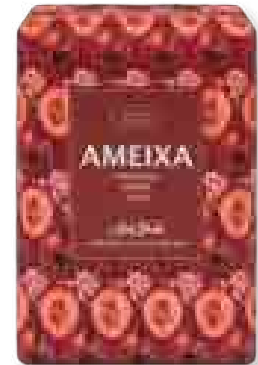

Frutados II 35605

Soap based on vegetable soap and enriched with coconut oil. When used this soap provides a creamy lather leaving the skin clean, soft and moisturized. Capacity up to 160 g. Environmentally friendly soap traditionally produced in Portugal.

A collection that aims to highlight vibrant fruity aromas:

Colour 108: Lemon-scented soap

Colour 115: Plum-scented soap

90 x 60 x 30 mm

STI



Spa 35607

Set of soaps that belong to the spa line, based on vegetable soap indicated for the needs of your skin, each with a different purpose. Produced traditionally in Portugal and is suitable for all skin types. Capacity up to 100g. Environmentally friendly product.

- Colour 102: Purifying Soap - Clay and Verbena
- Colour 109: Refreshing Soap - Mint and Raspberry
- Colour 131: Moisturizing Soap - Donkey's milk
- Colour 154: Exfoliating Soap - Algae and Sea Salt

53 x 83 x 24 mm

STI



Flores 35608

Pebble-shaped soap based on vegetable soap, with a soft texture that leaves the skin fragrant. Suitable for all skin types. Capacity up to 150g. Environmentally friendly soap. Packaging with classic illustrations.

- Colour 102: Rosalface soap
- Colour 108: Triple Alfazema soap
- Colour 119: Citrus soap

90 x 58 x 45 mm

STI





160



Arkin 95057

Shower brush in bamboo with natural boar bristles. Supplied in a kraft paper gift box.

📏 Brush: 447 x 82 x 12 mm | Box: 455 x 89 x 30 mm

➤ LSR, PDP



103

160



Delany 95056

Toothbrush with bamboo body and Nylon bristles. Supplied in a kraft paper gift box.

📏 Toothbrush: 175 x 14 x 5 mm | Box: 190 x 30 x 15 mm

➤ LSR, PDP



160



Ducasse 94574

Multi-purpose bag (120g/m²) in jute and cotton. Can be used as a plant pot.

📏 Ø150 x 130 mm | Fold: 50 mm

➤ TRS, TRD



160



Conroy 95063

Spa set including: PET (80% rPET) + PET bath puff with polyester handle, pumice stone with polyester cord and cotton and jute back towel exfoliating, with cotton handles.

📏 Shower puff: Ø100 mm | Washcloth: 690 x 80 mm | Pumice stone: 100 x 50 x 20 mm | Bag: 280 x 200 mm

➤ TRS, TRD



160



Downey 95058

Wooden anti-cellulite bath massage brush (250 g/m²). With a cotton handle to help when massaging the body. Supplied in a kraft box.

📏 Brush: 130 x 75 x 40 mm | Box: 135 x 80 x 45 mm

➤ LSR



160



Enos 95054

Bamboo comb. Supplied in a kraft paper gift box.

📏 Comb: 134 x 30 x 6 mm | Box: 150 x 35 x 10 mm

➤ LSR, PDP

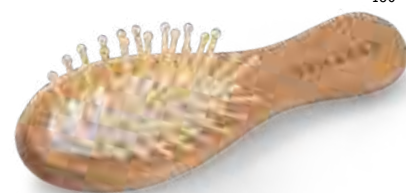

160



Dern 95055

Hairbrush with wooden handle and bamboo bristles. Ideal for travelling. Supplied in a kraft paper gift box.

📏 Brush: 156 x 43 x 25 mm | Box: 165 x 55 x 35 mm

➤ LSR, PDP

Versatile towels

The harmonious and balanced design of these pieces allows for various types of use from beach towel, bath towel, garment, or even as a decorative piece.

MADE IN EUROPE

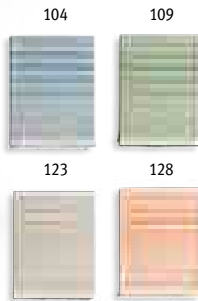

Malek 99046

Multifunctional bath towel (350g/m²) made of light and resistant cotton (85%) and recycled cotton (15%). With OEKO-TEX certification. Made in Europe.

100 x 180 cm
 TRS, EDB, ETD, TRD



Caplan 99045

Multifunctional towel made of light and resistant cotton (90%) and recycled cotton (10%). With OEKO-TEX certification. Made in Europe.

100 x 180 cm
 TRS, EDB, ETD, TRD

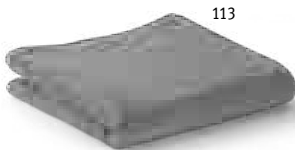
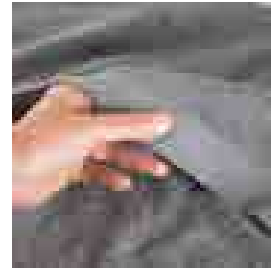

Bardem S 99049

Face towel (350 g/m²) in cotton (82%) and recycled cotton (18%). OEKO-TEX certification. Made in Europe.

300 x 300 mm
 TRS, EDB, ETD, TRD



Bardem M 99048

Hand towel (500 g/m²) in cotton (82%) and recycled cotton (18%). OEKO-TEX certification. Made in Europe.

1000 x 500 mm
 TRS, EDB, ETD, TRD



Bardem L 99047

Bath towel (500 g/m²) in cotton (82%) and recycled cotton (18%). OEKO-TEX certification. Made in Europe.

1400 x 700 mm
 TRS, EDB, ETD, TRD



The natural fabrics that offer the greatest comfort after bathing

MADE IN EUROPE



106



♂ Ruffalo 95068

Bathrobe (350 g/m²) made of cotton (82%) and recycled cotton (18%). It has a soft touch fabric, 1 adjustment belt and 2 pockets (1 on each side). Made in Europe.

📏 620 x 1150 mm

🔪 EDB, ETD



♀ Ruffalo Large 95053

Cotton (82%) and recycled cotton (18%) bathrobe (350 g/m²). It has a soft touch fabric, 1 adjustment belt and 2 pockets (1 on each side). With OEKO-TEX certification. Made in Europe.

📏 Sizes: L/ XL | 660 x 1190 mm

🔪 EDB, ETD

♀ Danes 95069

Unisex bedroom slippers in polyester with a soft finish. Supplied in a non-woven bag.

📏 280 x 112 mm

🔄 TRS, TRD



103



106



103

Several inside pockets
and hook on the top



Willis 92724

Microfibre toiletry bag with several pockets, hook and zipper.

200 x 160 x 85 mm

TR5 TRD



Several inside pockets
and hook on the top



Milli 92148

Toiletry bag in high density 600D. The main compartment has a two-way zipper and 210D lining. It contains several interior pockets and a convenient hanging hook on the top.

230 x 180 x 105 mm

TR5 TRD



Recycled PET

rPET is much more than recycled plastic. Its applications are many and can be present in many everyday objects.



Repurpose Bag 92078

600D PET (100% rPET) cosmetic bag with lined interior. Front zipper pocket and side webbing handle.

± 220 x 120 x 110 mm

TR5, TRD



Wayne 92732

Toiletry bag in high density 600D with handle, double zipper and lined interior.

± 220 x 110 x 110 mm

TR5, TRD



Kevin 92728

300D high density toiletry bag with handle, front pocket, lined interior and zipper.

± 220 x 115 x 115 mm

TR5, TRD

Colourful bags ideal for daily use or travel

Miller
93124
📄 .266



Marie 92721

Multi Use microfibre pouch with zipper.

📏 130 x 90 x 65 mm

🔪 TRS TRD



Loren 92713

PVC multipurpose bag with zipper, available in metallic colours.

📏 140 x 95 x 70 mm

🔪 SCR

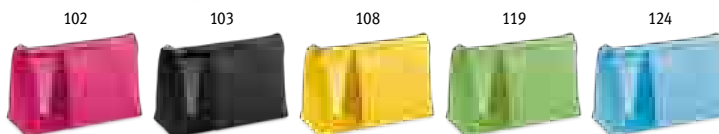

Annie 92717

Microfibre and mesh cosmetic bag with zipper.

📏 210 x 130 x 85 mm

🔪 TRS TRD



Eliza 92731

Cosmetic bag in high density 300D with padded handle and double zipper. Lined interior with zipped pocket.

± 200 x 115 x 140 mm

➤ TRS TRD



Blanchett 92735

Cosmetic bag in 100% cotton (280 g/m²) with cork details on the bottom and zip puller, which can also be used as a handle for easy transport. Lined interior, easy to clean and quick drying, ideal for storing make-up.

± 220 x 130 x 80 mm

➤ TRS TRD



Millie 92077

Multifunction bag (140 g/m²) in cotton (80% recycled) and zipper.

± 225 x 120 mm

➤ TRS TRD





106



Wireless quick charger

Bactout 98519



ABS and PC sterilizer case with combination of UVC and UVA radiation that allows the elimination of a wide spectrum of bacteria. The case has 2 UV leds inside with a total power of 2W, and has been specially designed for the elimination of bacteria in everyday objects, such as: keys, telephones, smartphones, masks, glasses, remote controls, jewellery and other small objects. Efficiency of 70% with only 1 cycle of 5 minutes and 99.9% with two cycles of 5 minutes. It has a safety sensor that turns off the lamps immediately as soon as the case is opened. The top of the box includes a wireless fast charger (10W), with 5V/3A input and USB type C charging port. Includes 1 metre cable. Supplied in a gift box.

∓ 210 x 120 x 55 mm | Interior: 190 x 95 x 20 mm | Box: 240 x 130 x 71 mm

➤ PDP, DUV, SCR



With hygienic gel



110

Gless 95107

Alcohol-based hand cleansing spray in 50ml PET bottle with flip top cap. Practical cosmetic product to take and use anywhere.

∓ Ø33 x 84 mm

➤ PDP, STI



106

Reflask 500 94913

Bottle with dispenser in PE and PP. Volume-capacity 500 mL, refillable and reusable.

∓ Ø85 x 150 mm

➤ PDP, STI



119

103



105



106



114



119



124



128



Maurice 94952

Silicone strap for transport with three adjustment levels.

∓ 20 x 139 mm





Ingrid 92733
 Multipurpose bag with an EVA insert. The zipper is available in a variety of colours. Suitable for air travel.
 150 x 125 mm
 SCR



Margot 92741
 Airtight EVA cosmetic bag with zipper. Ideal for travelling by plane.
 190 x 150 x 50 mm
 SCR



Chastain 92737
 Eva cosmetic bag with zipper and metal zip puller. Ideal for travelling by plane.
 200 x 145 x 70 mm
 SCR



Moore 92734
 Multi-purpose bag with an EVA compartment, with zipper closure. Suitable for air travel.
 150 x 160 mm
 SCR



Valentina 92720
 Airtight PVC cosmetic bag. Suitable for travelling by plane.
 165 x 185 x 40 mm | Capacity < 1 Liter
 SCR



Deniro 92722
 Airtight PVC cosmetic bag that includes 3 bottles (2 x 65 mL and 1 x 60 mL), 1 vaporiser (80 mL) and 1 funnel. Ideal for travelling by plane.
 190 x 155 x 40 mm
 PDP, SCR



Eric 94891

SPF30 sunscreen with a capacity of 30 mL. The sunscreen package has a metal carabiner. Legal information available at: PT; EN; ES; FR; IT; DE; PL; CZ; SK; RO; RS; HR; NL; HU; DK; NO; SV; BG.

∓ 93 x 50 x 23 mm

➤ PDP, STI

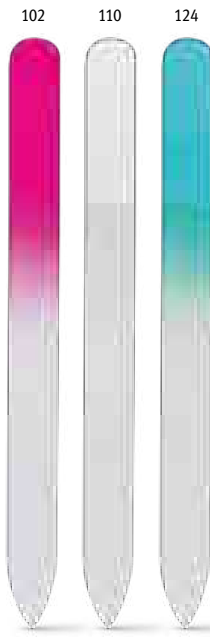

Raspera 94861

Glass nail file. Supplied in a pouch.

∓ 12 x 140 x 3 mm

➤ PDP, DOM



Streep 94853

Practical round shaped mirror. An ideal size to carry in a handbag.

∓ Ø60 x 5 mm

➤ PDP, DUV, SCR

Lip balms with UV protection



Scarlett 94880

Lip balm with ABS packaging with metallic finish. Legal information available at: PT; EN; ES; FR; IT; DE; PL; CZ; SK; RO; RS; HR; NL; HU; DK; NO; SV; BG.

∓ Ø18 x 68 mm

➤ PDP, SCR



Alba 94882

Lip balm with ABS round-shaped packaging with metallic finish. Legal information available at: PT; EN; ES; FR; IT; DE; PL; CZ; SK; RO; RS; HR; NL; HU; DK; NO; SV; BG.

∓ Ø39 x 38 mm

➤ PDP



Jolie 94851

Lip balm in PS and PP available in different colours. Legal information available at: PT; EN; ES; FR; IT; DE; PL; CZ; SK; RO; RS; HR; NL; HU; DK; NO; SV; BG.

∓ Ø19 x 68 mm

➤ SCR, DUV, PDP



107

Shimmer 94860

Double make-up mirror in metal, practical and compact to use whenever necessary. The mirror has a slot for doming customisation. Supplied in a gift box.

Box: 67 x 75 x 9 mm

LSR, DOM



160



Tilbury 94898

Double round mirror in cork with soft magnet closure. Supplied in a natural paper pouch.

Ø73 x 20 mm

LSR



160



Zena 94897

Cork manicure set with 5 stainless steel pieces: nail file, scissors, nail clipper, tweezers and a double ended cuticle pusher. Supplied in a natural paper pouch.

104 x 61 x 17 mm

LSR



106

112

Nadia 94843

Four-piece manicure set with nail clipper, scissors, tweezers and cuticle pusher. Supplied in a case.

100 x 53 x 20 mm

PDP, DOM, DUV, SCR



106



103

Diaz 94849

Sonia 94848

Five-piece manicure set with nail file, scissors, nail clipper, tweezers and cuticle pusher. Supplied in a PU case.

110 x 65 x 20 mm

SCR





106

Rugby 98092

Rugby ball shaped stress reliever in PU foam.

∓ 91 x 58 x 58 mm

➤ LSR, DUV, PDP

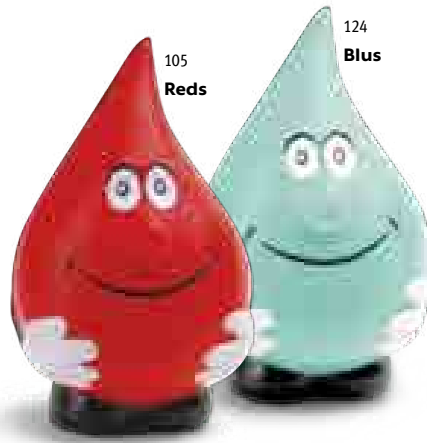

105
Reds

124
Blus

Reds 98059 / **Blus** 98067

Teardrop shaped stress reliever in PU foam.

∓ 65 x 110 x 65 mm

➤ LSR, DUV, PDP



105

Deep 98012

Anti-stress PU foam, heart-shaped.

∓ 65 x 70 x 50 mm

➤ PDP, DUV, LSR

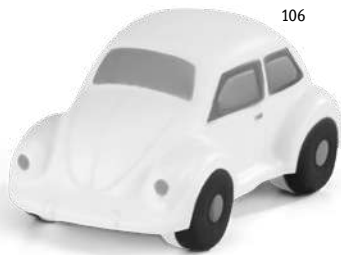

106

Lohan 98091

Car shaped stress reliever in PU foam.

∓ 52 x 93 x 47 mm

➤ PDP, DUV, LSR



103

Neeson 98093

Football shaped stress reliever in PU foam.

∓ Ø63 mm

➤ PDP



119

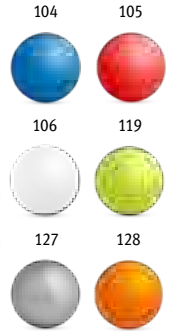

Chill 98054

Ball shaped stress reliever in PU foam.

∓ Ø50 mm

➤ PDP, DUV, LSR



124

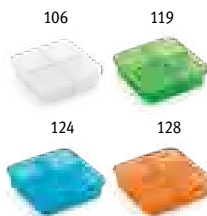

Roberts 94306

Pill box with 4 dividers and lid.

∓ 60 x 60 x 18 mm

➤ PDP, DUV, SCR



106



Jimmy 94305

Pill box with lid and 7 compartments, ideal to separate pills by weekdays.

∓ 85 x 55 x 20 mm

➤ PDP, DUV, SCR

Reusable



Lovely 94356

Heart shaped heated pouch in PVC, that generates heat instantly by squeezing the metal piece inside.

∓ 102 x 90 x 11 mm

➤ PDP

Reusable



Corden 94353

Heated pouch in PVC that generates heat instantly by squeezing the metal piece inside. Promotional product.

∓ 88 x 110 mm

➤ PDP



Troye 98114

PU foam earplugs. Product supplied in PVC box.

∓ Ø14 x 26 mm | Box: 35 x 35 x 15 mm

➤ PDP, DUV, SCR

Retractable for travel



Harper 94855

PP toothbrush with protective cover, practical to take when travelling.

∓ Closed: 111 x 21 x 15 mm

➤ PDP, DUV



Tablet cutter

Nero 94307

Pill box with lid, 2 removable, different coloured compartments and separate cutter enabling management and transport of medication

∓ 94 x 48 x 16 mm

➤ PDP, DUV, SCR



Piaf 94800

Make-up mirror with foldable brush.

∓ 105 x 35 x 25 mm

➤ SCR, DUV, PDP





Lone 93318
Metal and PU double business card holder. Supplied in a gift box.
93 x 67 x 19 mm | Box: 98 x 72 x 22 mm
LSR



Sandler 93309
Mirrored metal and PU business card holder. Supplied in a gift box.
95 x 65 x 13 mm | Box: 105 x 70 x 15 mm
LSR, TRD, TRS

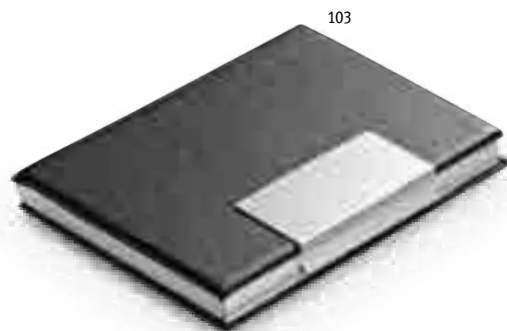

Reeves 93307
Aluminium and PU card holder. Supplied in a gift box.
96 x 64 x 13 mm | Box: 105 x 70 x 15 mm
LSR

RFID blocking

Ensures the security of your cards and prevents data theft.

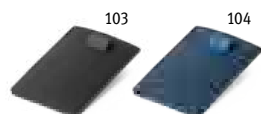

Poppy 93265
RFID blocking card holder in PU with polyester strap to easily remove the cards. Capacity to store up to 2 cards.
92 x 65 x 2 mm
SCR

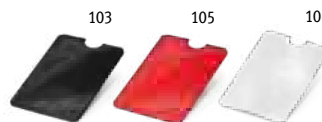

Meitner 93333
Aluminium credit card protector with RFID blocking technology, with capacity for one card.
92 x 63 mm
SCR



Travolta 93314

Set with business card holder and keyring. Both products are PU and metal. Supplied in a gift box.

Keychain: 15 x 92 x 8 mm |

Cardholder: 97 x 65 x 11 mm | Box: 154 x 143 x 34 mm

LSR, SCR



123



Daniel 93319

Cork business card holder with capacity for 4 cards includes side compartment for bills. Supplied in a kraft paper gift box.

68 x 106 mm | Box: 75 x 115 x 15 mm

LSR, SCR, TRD, TRS

For 4 cards



160



Affleck 93317

RFID blocking leather wallet with a coin pocket, bills pocket and inserts for 9 cards. Wallet supplied in a gift box.

110 x 92 x 13 mm | Box: 130 x 109 x 24 mm

SCR, HTS

For 9 cards



103

Ideal to carry documents while on the move



Airline 92132

Travel document pouch in 600D with 2 interior compartments and identification window. Self-adhesive hook and loop fastener.

± 275 x 140 mm
 TRS, TRD



In aluminium

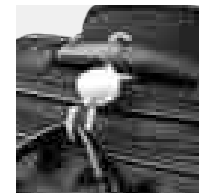
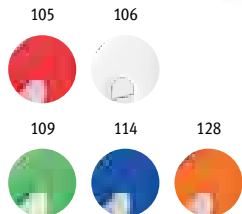

Findo 98124

PP ID tag, ideal for suitcases.

± 87 x 50 x 4 mm
 PDP, DUV

Emil 98111

Aluminium ID tag with lanyard, ideal for suitcases.

± 80 x 42 x 2 mm
 LSR

Oren 23200

Carabiner hook, ideal for hanging hand luggage on the trolley.

± 44 x 130 x 18 mm
 PDP, DOM

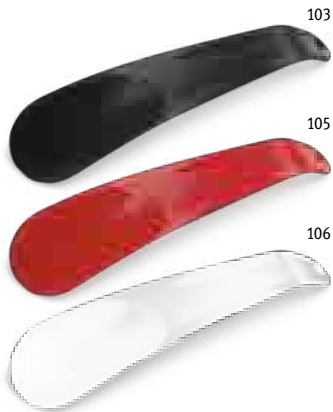

MADE IN EUROPE

Renau 98108

PS shoehorn with a hole at the end for hanging. Made in Europe.

153 x 38 mm
PDP DUV



Gweno 92851

Non-woven (80 g/m²) drawstring shoe bag.

360 x 420 mm
TXP TRD, TRS



Cobb 98117

Shoe cleaning kit with 6 pieces: box, shoehorn, 2 brushes, cloths and grease. Ideal set to always keep your shoes clean and shiny. Available in circular shaped metal box.

Ø98 x 56 mm
LSR, SCR



Checkin 97388

Mini digital ABS scale for a maximum weight of 40 kg. Ideal for suitcases. Includes 1 CR2032 battery.

37 x 100 x 27 mm
PDP



Bilbo 94879

Convenient and lightweight travel sewing set. Sewing kit consisting of 3 pins, 3 needles, 1 pair of tweezers, 1 pair of scissors, 1 needle threader, 1 safety-pin, 2 buttons, 2 hooks and eye closures and 6 spools of thread in several colours. Supplied in a hard case.

70 x 21 x 65 mm
PDP, DOM, DUV, SCR

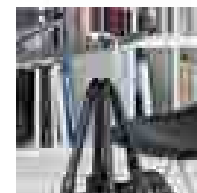

Florence 94899

Sturdy metal suitcase stand. The stand can be placed on a surface to hang your suitcase.

Ø45 x 8 mm
PDP, DOM





103

Dozy 98113

Practical 190T sleeping mask with padded interior.

± 185 x 90 mm

➤ TRS, TRD



104

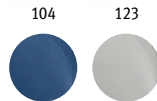

104

123

Strada 98180

Inflatable neck travel pillow, soft to the touch. Supplied in a pouch.

± Empty: 425 x 275 mm | Pouch: 175 x 115 mm

➤ SCR



103

Travelx 98197

Travel set with an inflatable neck pillow, sleeping mask, earplugs (not a personal protective equipment) and 1 pair of socks. Supplied in a 190T pouch.

± Pouch: 150 x 200 mm

➤ SCR, TRD, TRS



103

Fontaine 98196

Non-woven garment bag (70 g/m²) with zipper and handle for easy transport.

± 600 x 1000 mm

➤ TRS, TRD



103

Seventh 98171

Non-woven garment bag (80 g/m²) with zipper and handle for easy transport.

± 650 x 1090 mm

➤ TRS, TRD

KEYCHAINS

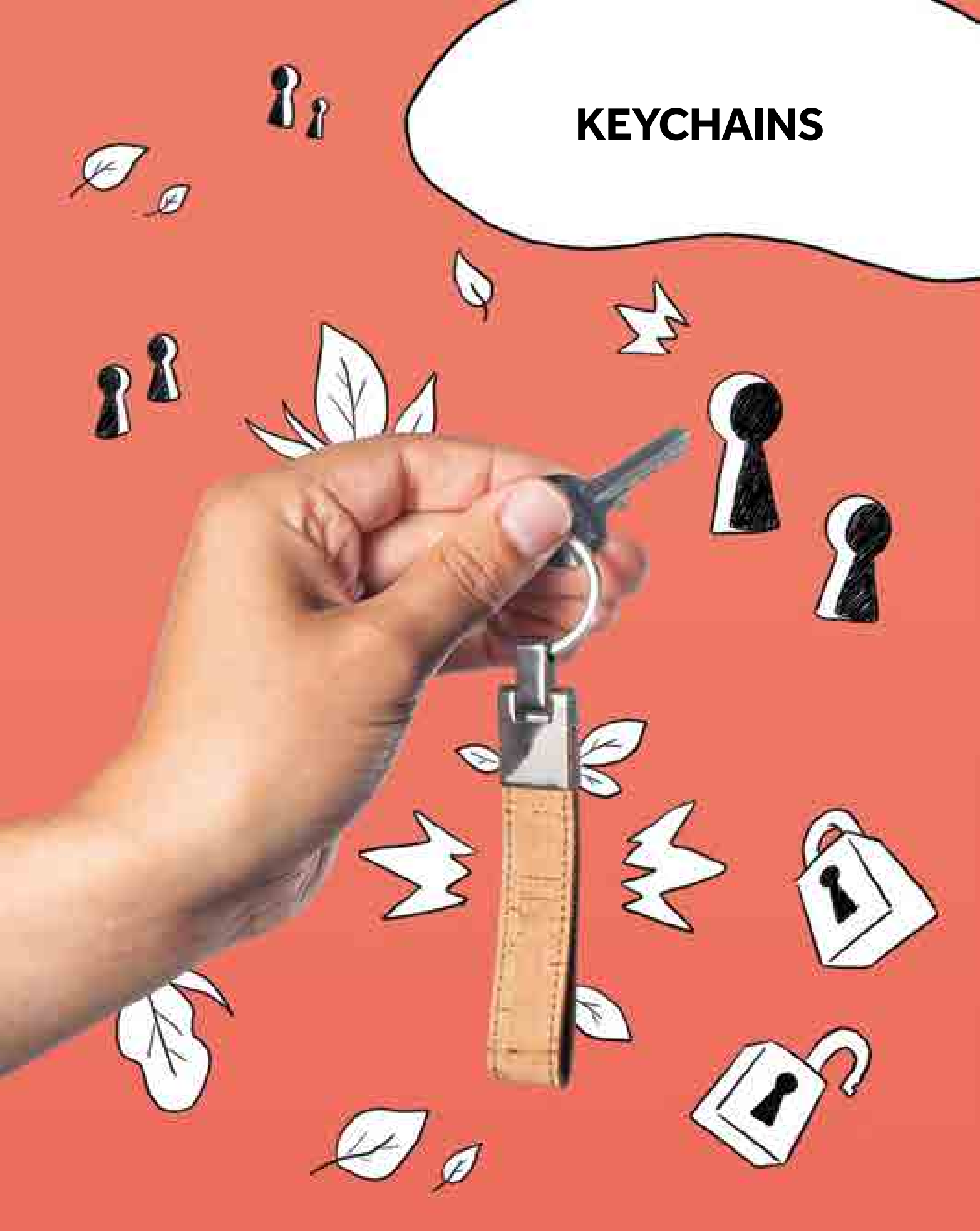



160



Millau 95051

Cork keyring. Supplied with a self assembly kraft paper box.

35 x 55 x 3 mm

PDP, LSR



160



Corks 93145

Cork and metal keyring. Supplied in a kraft paper gift box.

20 x 100 mm | Box: 54 x 125 x 16 mm

LSR, DUV, SCR, TRD, TRS

Keyring

Incorporate natural materials in your day to day objects.



160



Homer Round 95071

Circular bamboo keyring with a metal casing. Supplied with a kraft paper box.

36 x 40 x 4 mm
LSR, DOM, PDP



160



Homer Square 95070

Rectangular bamboo keyring with a metal casing. Supplied with a kraft paper box.

22 x 47 x 5 mm
LSR, DOM, PDP

Ideal products to customise with doming



Ringbolt 93368
 Metal keyring with area for doming, with bottle opener and carabiner. Supplied in a gift box.
 29 x 52 x 4 mm
 LSR, DOM, SCR



Albright 93177
 Metal and PU keyring suitable for customisation by doming
 39 x 57 x 5 mm
 LSR, DOM, PDP



Zabel 93158
 Metal keyring ideal for customisation with doming technique. Supplied in a gift box.
 30 x 54 x 4 mm
 PDP, DOM, LSR, SCR

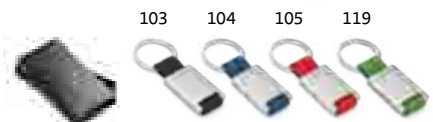

Anchor 93369
 Metal and webbing keyring with area for doming. Supplied in a gift box.
 27 x 61 x 5 mm
 LSR, DOM, SCR

Several colours that adapt to your needs. Take the opportunity to make a difference!



Bale 93143
Metal and PU keyring. Supplied in a gift box.
22 x 65 x 8 mm
LSR, DOM, SCR



Bachmann 93171
Metal Keyring with PU surround. Supplied in a gift box.
38 x 76 x 9 mm
LSR, PDP, SCR



Bouchier 93363
Metal and PU keyring with hook. Supplied in a gift box.
21 x 77 x 8 mm
LSR, SCR



Travolta
93314
.249

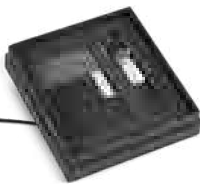

Bumper 93178
Metal and PU keyring. Supplied in a gift box.
20 x 56 x 5 mm
LSR, SCR

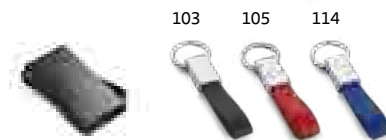

Watch 93354
Round metal and PU keyring. Supplied in a gift box.
18 x 90 x 7 mm
LSR, SCR

Original formats for different gifts



Gripitch 93077
 Metal and webbing keyring. Supplied in a gift box.
 28 x 60 x 6 mm
 LSR, PDP, SCR



Ulrich 93084
 House-shaped metal keyring. Supplied in a gift box.
 49 x 36 x 3 mm
 LSR, SCR



Homier 93167
 House-shaped aluminum keyring.
 38 x 35 x 2 mm
 PDP, LSR



Paw 93364
 Bone shaped aluminium keyring.
 38 x 25 x 1 mm
 LSR, PDP

Keychains with useful features for your day-to-day life

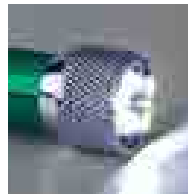

Porthos 93399
Metal keyring with coin for supermarket cart. Supplied in a gift box.
⊥ 32 x 40 mm | Coin: Ø24 mm
/ LSR, SCR



Fido 93089
Coin-shaped metal keyring.
⊥ 23 x 80 mm
/ LSR



Lergan 93141
Aluminium keyring with a 3 LED flashlight. Includes 4 LR44 batteries.
⊥ Ø17 x 62 mm
/ LSR, PDP

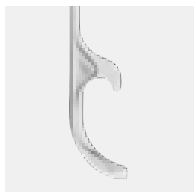

Helli 93394
Metal keyring with bottle opener.
⊥ 22 x 42 x 9 mm
/ LSR

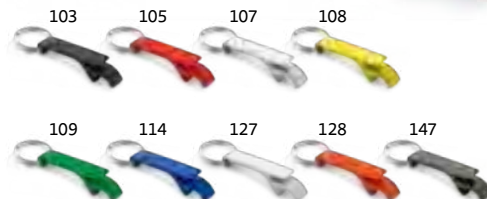

Baitt 93151
Aluminium keyring with bottle opener.
⊥ 11 x 60 x 15 mm
/ SCR, LSR

Key ring with extra functions



Coppi 94129
Keyring with 1.5 metre tape measure with brake.
⊥ 60 x 48 x 15 mm
➤ PDP, DUV



Ashley 94124
Keyring with 1 metre measuring tape.
⊥ 40 x 40 x 9 mm
➤ PDP, DUV, SCR

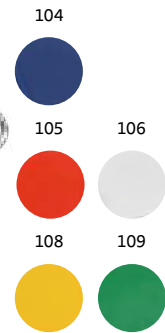

Matthew 58823
Aluminium carabiner, with keyring and flat area for customisation. Not suitable for climbing.
⊥ 32 x 57 x 5 mm
➤ LSR

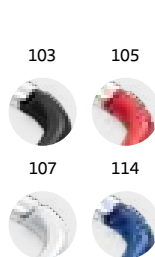

Close 98824
Aluminium carabiner with bottle opener. Product not suitable for climbing.
⊥ 44 x 79 x 3 mm
➤ LSR, SCR

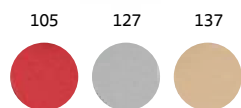
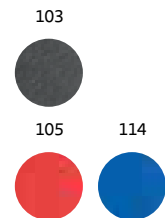

Handy 95049
Aluminium keyring with bottle opener. Due to its design, it can be used to open doors and its tip allows the use of buttons, such as the A™ or the elevator.
⊥ 37 x 88 x 4 mm
➤ LSR, SCR

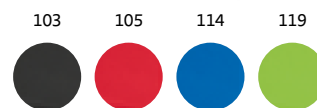

Handy Safe 95048
ABS keyring. Due to its design, it can be used to open doors and its tip allows the use of buttons, such as the A™ or the elevator.
⊥ 38 x 69 x 5 mm
➤ PDP



Antibacterial treatment

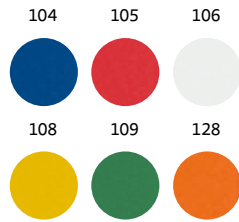

MADE IN EUROPE

Sullivan 95018

Coin-shaped PS keyring for supermarket cart. Made in Europe.

25 x 60 x 2 mm

DGL



MADE IN EUROPE

Boling 93063

Circular shaped clear PS keyring. Made in Europe.

∅40 x 5 mm

DGL



MADE IN EUROPE

Lime 93062

Rectangular shaped clear PS keyring. Made in Europe.

35 x 58 x 6 mm

DGL



MADE IN EUROPE

Bowen 93056

Square shaped clear PS keyring. Made in Europe.

43 x 55 x 5 mm

DGL



MADE IN EUROPE

Belair 93076

Rectangular shaped clear PS keyring. Made in Europe.

31 x 73 x 5 mm

DGL

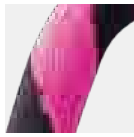

TUBE ORIGINAL

40 colors available in stock



Elastic available in all Pantone® colors.

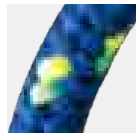

NAUTIC

12 colors available in stock



Elastic available in all Pantone® colors.

MADE IN EUROPE

LANYARD'IN

.324

75093

Custom Lanyard long tube in polyamide with 40 standard colours available for customisation. Includes the following accessories and extras: elastic available in all Pantone® colours; 43 x 15 mm sublimation label and a Ø32mm ring.

∅7 x 470 mm

SUB



75093



75089



75090



75092



75091

75089

Custom Lanyard long tube in polyamide with 40 standard colours available for customisation. Includes the following accessories and extras: elastic available in all Pantone® colours; 43 x 22 mm sublimation label; 55 mm metal hook and Ø6 mm safety lock.

∅7 x 470 mm

SUB

75090

Custom Lanyard short tube in polyamide with 40 standard colours available for customisation. Includes the following accessories and extras: elastic available in all Pantone® colours; 43 x 15 mm sublimation label and a small 9 mm carabiner.

∅7 x 150 mm

SUB

75092

Custom Lanyard short nautic in polyester with 12 standard colours available for customisation. Includes the following accessories and extras: elastic available in all Pantone® colours; 43 x 15 mm sublimation label and a small 9 mm carabiner.

∅7 x 150 mm

SUB

75091

Custom Lanyard long nautic in polyester with 12 standard colours available for customisation. Includes the following accessories and extras: elastic available in all Pantone® colours; 43 x 22 mm sublimation label, metal hook with 55 mm and Ø6 mm security lock.

∅7 x 470 mm

SUB

CORK

COTTON

Lanyards made from **100%**
natural material: cotton



Seccur

94970

📏 .160



106

Mendoza

94976

Lanyard bracelet in polyester. Sublimation on one side of the bracelet. Security lock included.

📏 Customisation area: 15 x 640 mm. Bracelet dimensions: 15 x 320 mm.

🔪 SUB



106

Hobart

94975

Lanyard bracelet in polyester. Sublimation on both sides of the bracelet. Security lock included.

📏 Customisation area/side: 15 x 640 mm. Bracelet dimensions: 15 x 320 mm.

🔪 SUB



333



75096

Customisable Lanyard cork. Includes the following accessories and extras: Cotton label (43 x 15 mm); carabiner (9 mm) and safety lock.

📏 Ø5 x 470 mm

🔪 SUB



150

Removable wheat straw fibre buckle



Ballina

94410

100% cotton lanyard with metal carabiner. Removable buckle and safety lock in wheat straw.

📏 20 x 510 mm

🔪 TRS, TRD



150

Heathrow

94411

100% cotton lanyard with metal carabiner.

📏 20 x 480 mm

🔪 TRD, TRS



124



119



105



106



Murray 94402

Polyester lanyard with metal carabiner, removable buckle, mobile phone strap and safety lock.

20 x 510 mm

TRD



Anquetil 94401

Polyester lanyard with metal carabiner, removable buckle and mobile phone strap.

20 x 530 mm

TRD



Lariat 94405

Polyester lanyard with metal carabiner.

20 x 480 mm

TRD, TRS

MADE IN EUROPE

Manila 94977

Polyester sublimation lanyard with carabiner. The customisation can be on both sides of the lanyard.

Customisation area/side: 20 x 940 mm. Cord dimensions: 20 x 470 mm.

SUB

Get to know all the Lanyards
all suitable for sublimation

MADE IN EUROPE

Sublimation lanyards

They allow quality printing on both sides of the ribbon on two different types of materials: rPET and polyester.

 .328



106



MADE IN EUROPE

Brighton 94972

Polyester sublimation lanyard with carabiner. The customisation can be on both sides of the lanyard. Made in Europe.

20 x 470 mm

 SUB



106



MADE IN EUROPE

Bristol 94971

Polyester sublimation lanyard with carabiner and safety lock. The customisation can be on both sides of the lanyard. Made in Europe.

20 x 470 mm

 SUB



106



MADE IN EUROPE

Windsor 94974

PET (100% rPET) sublimation lanyard with carabiner. The customisation can be on both sides of the lanyard. Made in Europe.

20 x 470 mm

 SUB



106



MADE IN EUROPE

Dover 94973

PET (100% rPET) sublimation lanyard with carabiner and safety lock. The customisation can be on both sides of the lanyard.

20 x 470 mm

 SUB



114



Nicolaus 94446

Silicone card holder. Includes lanyard and smartphone holder.

Card holder: 57 x 86 x 4 mm | Lanyard: 420 mm

✓ SCR

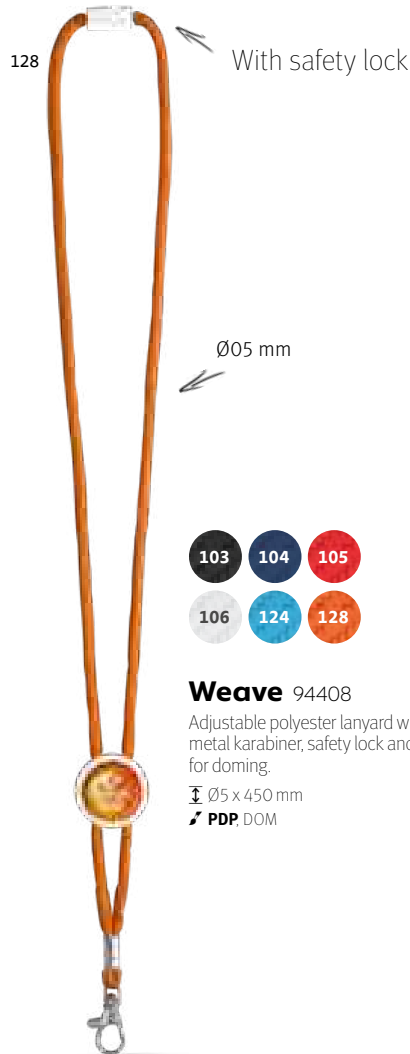

128

With safety lock

Ø05 mm



Weave 94408

Adjustable polyester lanyard with metal karabiner, safety lock and slot for doming.

Ø5 x 450 mm

✓ PDP, DOM



Yeats 53569

Extendable badge holder. Up to 900 mm. Clear clip and button to add card or pass holder. Retractable mechanism allows the card or credential to be presented safely and comfortably.

Ø32 x 9 mm

✓ PDP, DOM



119

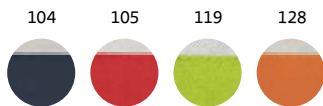

Miller 93124

Small multipurpose pouch in 600D with zipper and a keyring inside.

120 x 80 mm

✓ TRS, TRD



110



Whitman 93359

Vertical badge holder in PVC. This badge holder has holes that allow the use of a carabiner.

110 x 170 mm

✓ PDP, SCR



110



Forsyth 93357

Horizontal badge holder in PVC. This badge holder has holes that allow the use of a carabiner.

110 x 90 mm

✓ PDP, SCR

KIDS



Playing with wood

Fun and exciting traditional games for children.

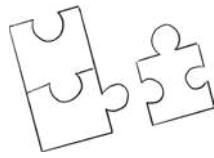

150

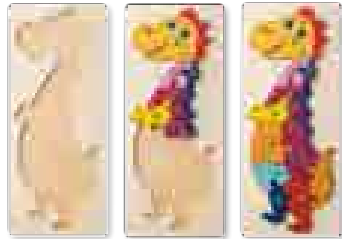

Diplodoco 98003

Dinosaur-shaped puzzle in pine plywood. Each part is numbered to aid assembly. The base, also in plywood, is customizable. Supplied in a kraft paper gift box.

📏 128 x 298 mm

🔪 LSR, DUV

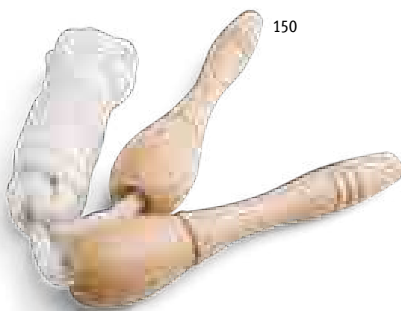

150

Jumpi 98031

Skipping rope with wooden handles, ideal for playing outdoors.

📏 Handle: Ø40 x 80 mm | Rope: 2200 mm

🔪 LSR, PDP



100



Gamy 98007

Set with 24 cube-shaped games. Supplied in a gift box.

📏 Each game: 40 x 40 x 40 mm | Box: 255 x 170 x 42 mm

🔪 PDP



119



Triceratops 98098

20 piece memory game with dinosaur figures, lightweight and easy to carry. The box is customized and can be used to save the game.

▮ Piece size: 50 x 50 x 1 mm | Box: 56 x 54 x 35 mm

➤ STI

100% cotton bag



150

Crosses 98097

Classic 10-piece playwood Tic Tac Toe game. The 100% cotton bag (140 g/m²) with drawstring closure serves as a game board. Lightweight and practical to play anywhere.

▮ Pieces: Ø25 mm | Pouch: 120 x 130 mm

➤ TRS, TRD



150

Domin 98074

Kid's wooden domino game with pieces with animal figures. Supplied in a customisable wooden box.

▮ 147 x 50 x 30 mm

➤ LSR, PDP, SCR

+ 60 stickers;
6 sheets to place stickers

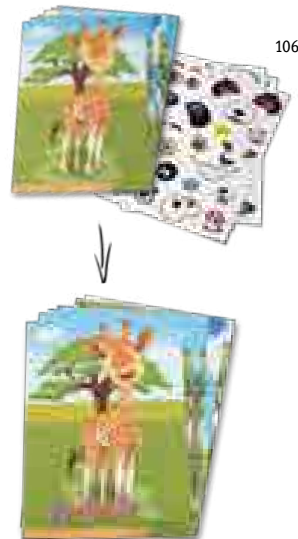

106

Madagascar 98002

Sticker set consisting of six sheets with animal figures to decorate: monkey, donkey, giraffe, elephant, cow and panda. With over 60 stickers for a lot of fun.

▮ Sheets size: 140 x 210 mm | Cardboard header: 165 x 50 mm

➤ PDP, STI



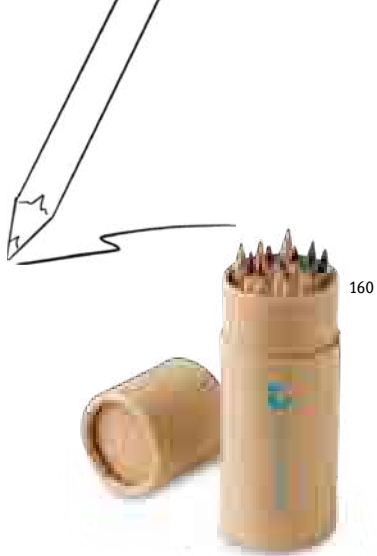

Cylinder 91752

Cylindrical Kraft paper box with 12 colouring pencils.

∓ Ø35 x 97 mm

➤ PDP, SCR, STI



Rols 91751

Cylindrical sharpening box with colouring pencils. Includes a colorful lid with sharpener.

∓ Ø26 x 106 mm

➤ STI, PDP, SCR

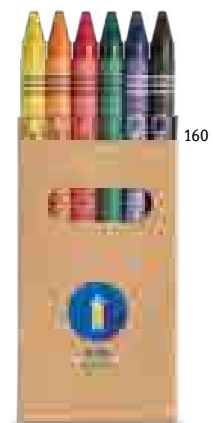

Eagle 91754

Kraft paper box with 6 crayons.

∓ 53 x 92 x 9 mm

➤ PDP, DUV, SCR



Croco 91746

Plain Kraft paper box with 12 colouring pencils.

∓ 90 x 180 x 9 mm

➤ PDP, DUV, SCR

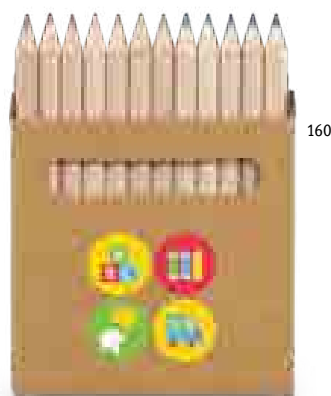

Coloured 91747

Kraft paper box with 12 colouring pencils.

∓ 90 x 90 x 9 mm

➤ PDP, DUV, SCR

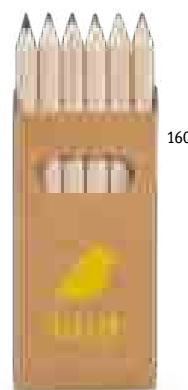

Bird 91750

Kraft paper box with 6 colouring pencils.

∓ 45 x 90 x 9 mm

➤ PDP, DUV, SCR



Memling 91767

Box with 6 small fluorescent wooden colouring pencils.

∓ 90 x 10 x 48 mm

➤ SCR



160

Faune 99336

Wooden set for painting. This set contains 3 figures with hanging ribbons and 4 colouring pencils.

122 x 94 x 14 mm

PDP, DUV, SCR



150

Doodle 91756

Drawing set supplied in wooden box. Includes a 20 cm ruler, 6 colouring pencils, 1 graphite pencil, a sharpener and an eraser.

220 x 43 x 32 mm

PDP, LSR, SCR

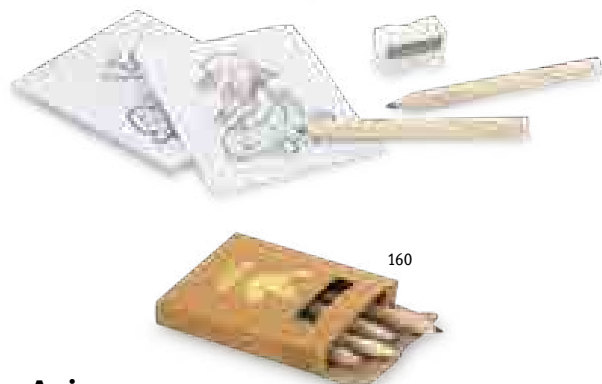

160

Anim 91758

Colouring set supplied in a Kraft paper box. This set includes 6 colouring pencils, 1 sharpener and 15 cards with drawings to colour.

73 x 89 x 12 mm

SCR, DUV



160

Jaguar 91755

Colouring set supplied in a Kraft paper box. This set includes 8 crayons and 8 cards with drawings to colour and hang.

180 x 90 x 10 mm

SCR, DUV, PDP

Large size: **Ø22 mm**

Parrot 91940

Paper box with 4 coloured chalk sticks. Supplied in a kraft paper gift box.

Chalk: Ø22 x 106 mm | Box: 98 x 109 x 26 mm

DUV, SCR

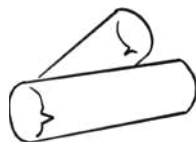

160



124

Rocket 92614

Backpack in 600D with front pocket and 2 side mesh pockets.

☒ 240 x 320 x 80 mm

➤ TRS, TRD



119

124

Bissaya 92617

Non-woven drawstring bag (80 m/g²) with colourful triangular corners.

☒ 300 x 350 mm

➤ TXP, TRD, TRS

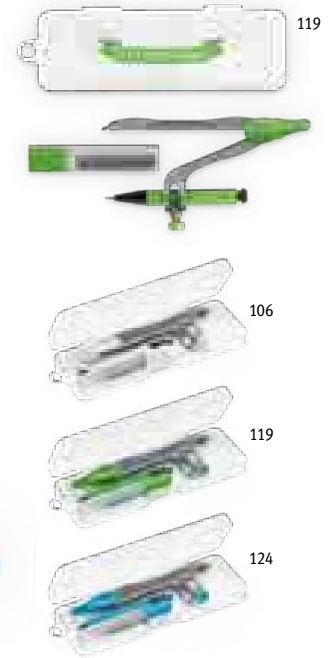

119

106

119

124

Geom 93575

Geometry school set in a PP case. Includes 1 compass, 1 mechanical pencil and 10 0.5 mm leads.

☒ 128 x 42 x 20 mm

➤ PDP, SCR



119



1+1=2



Turtle

58412

☒ .120



104

105

119

124

128

Hummingbird 93614

600D pencil case with a cylindrical design. The zippered closure matches the easy-open handles. Available in a wide range of colours. Ideal for carrying pencils.

☒ 210 x 85 x 65 mm

➤ TRS, TRD



150

Schooli 93607

Cotton (100%) pencil case with a cylindrical design. Zipper closure matches the easy-open handles. Ideal for carrying pencils.

☒ Ø70 x 220 mm

➤ TRS, TRD

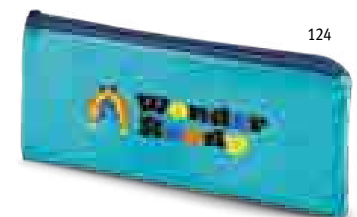

124

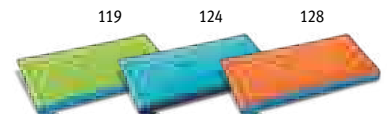

119

124

128

Colorit 93619

Non-woven zippered pencil case. Features a rectangular design. Ideal for carrying colouring pencils.

☒ 210 x 110 mm

➤ TRS, TRD



Stimulating creativity

Painting is one of the most complete activities, as it helps to stimulate and develop creativity.



Draws 92619

Non-woven drawstring bag (80 m/g²) with childrens drawing to colour. This product is supplied with 4 markers. Ideal set to offer to occupy kids.

± 300 x 350 mm
 TXP, TRD, TRS



Lavender 99826

Non-woven kids apron (80g/m²) with pocket and adjustable straps.

± 400 x 600 mm | Pocket: 200 x 150 mm
 TXP, TRD, TRS



Nilo 99834

Non-woven kids apron (80/m²) with drawing to colour, side pocket and adjustable straps. Includes 4 markers.

± 380 x 430 mm
 TRS, TRD

3 colouring pictures



Tejo 94635

PP and PS travel cup with flexible straw and volume-capacity of 200 mL. Set with 3 colouring pages and 4 coloured pencils. Supplied in a gift box.

± Ø72 x 98 mm | Box: 90 x 117 x 75 mm
 PDP

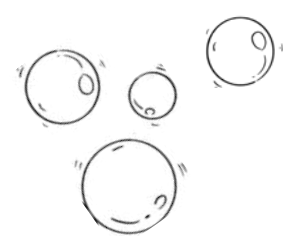

Bubbly 98076
 PP tube with soap bubbles. Volume 30 mL and liquid included.
 ∅25 x 130 mm
 PDP, DOM, STI

Aldan 98457
 PP beach bucket with 6 beach accessories ideal for playing in the sand.
 110 x 155 x 90 mm | Bucket: ∅88 x 89 mm
 PDP

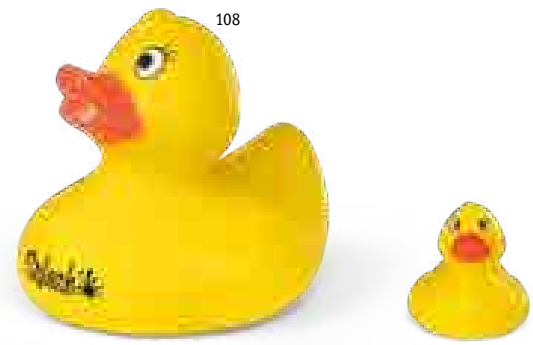

Duck 98077
 Yellow PVC rubber duck, ideal for playing in the water.
 70 x 72 x 80 mm
 PDP

105



106



114



114

Customisable on front and back



106

Bear 95500

Teddy bear plush toy with t-shirt on. T-shirt available in multiple colors and customisable front and back. Ideal as a gift for the kids.

± 120 mm

TRRS TRD

Grizzly 95504

Teddy bear plush toy with t-shirt on. T-shirt customisable front and back. Ideal as a gift for the kids.

± 155 mm

TRRS TRD



101

Moose 99063

Polar fleece blanket (180 g/m²) with reindeer plush.

± Blanket: 1200 x 800 mm | Plush toy: 200 x 245 mm

TRRS EDB, ETD, TRD



113



111

Beary 95505

Teddy bear plush toy. White front area can be customised.

± 155 mm

TRRS TRD



119



Chilka 99456

Polyester children's cap with ventilation holes. Adjustable self-adhesive hook and loop fastener. Available in a wide range of colours.

Size: 540 mm

TR S, EDB, ETD, TRD



100

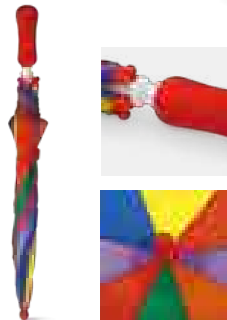

Bambi 99133

Colourful polyester kid's umbrella with manual opening and EVA handle.

Ø680 x 550 mm

TXP, TRD, TRS



108

Berry 93339

Bear-shaped fluorescent keyring.

60 x 66 mm

PDP



108



128

Mike 98501

100% polyester reflective kids' vests. This product features 2 horizontal reflective bands, a side self-adhesive hook and loop fastener and has EN 17353 certification.

One size: 370 x 470 mm

TR S, TRD, TXP

SUMMER

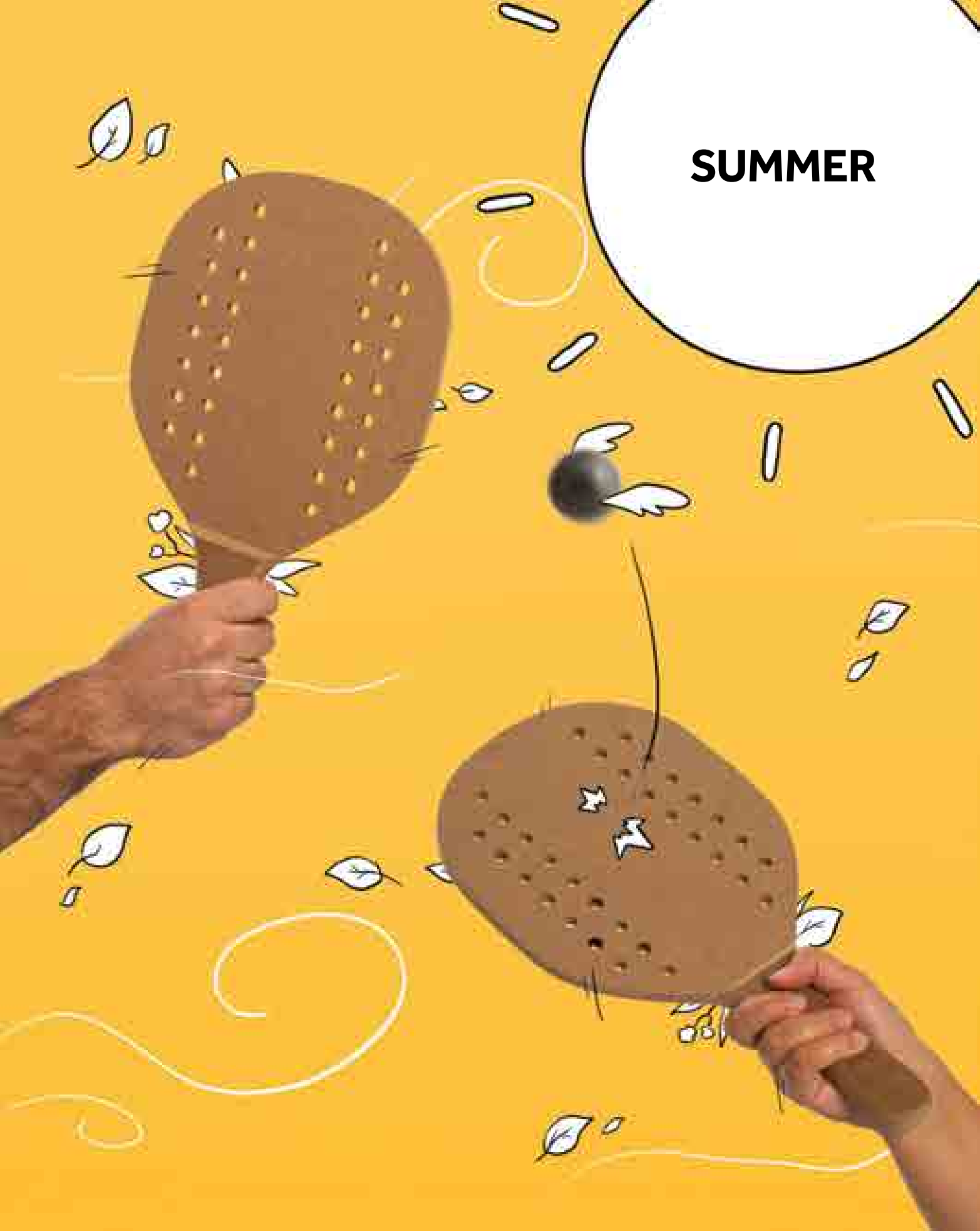



↗
Caplan
99045

📦 .281

↖
Tapia
98144

📦 .285

Your summer look with fully customisable flip-flops



Bali S / M 95082

Comfortable slippers with EVA soles and PVC straps. The sole is fully customisable with sublimation. Available sizes: S/M (36 to 39). Supplied in a polybag. This product can only be ordered with printing. Price includes personalization.

☒ S/M
➤ SUB



Bali L / XL 95083

Comfortable slippers with EVA soles and PVC straps. The sole is fully customisable with sublimation. Available sizes: L/XL (40 to 43). Supplied in a polybag. This product can only be ordered with printing. Price includes personalization.

☒ L/XL
➤ SUB

Flip-flops and the beach: the perfect combination for summer



Maupiti S / M 95084

Comfortable slippers with PE sole and PVC strap. Available in a wide range of colours. Sizes available: S/M (36 to 39). Supplied in a polybag.

☒ S/M
➤ PDP



Maupiti L / XL 95085

Comfortable slippers with PE sole and PVC strap. Available in a wide range of colours. Sizes available: L/XL (40 to 43). Supplied in a polybag.

☒ L/XL
➤ PDP

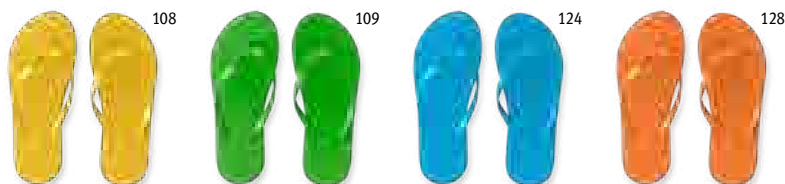



Steerable cable

104 105 123



Parana 98320

210T reclining beach umbrella with silver lining. Supplied in pouch with handle.

∅1400 mm | 1600 mm | Pouch: 1010 x 110 mm

TXP, TRD, TRS



104 105 106



Dering 98332

170T beach umbrella. Supplied in bag with handle.

∅1400 mm | 1600 mm | Pouch: 1000 x 120 mm

TXP, TRD, TRS

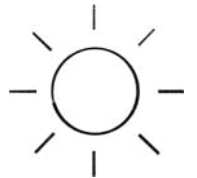

California 98377

Microfiber beach towel (250 g/m²), available in a wide range of colours.

1500 x 750 mm

TRS, EDB, ETD, TRD



MADE IN EUROPE

Versatile towels

The harmonious and balanced design of these pieces allows for various types of use from beach towel, bath towel, garment, or even as a decorative piece.

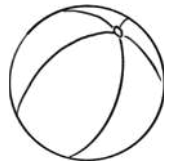

109



128

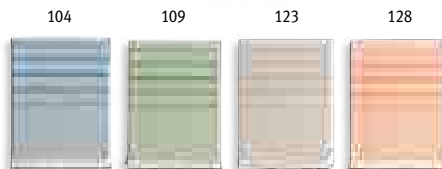

MADE IN EUROPE

Caplan 99045

Multifunctional towel made of light and resistant cotton (90%) and recycled cotton (10%). With OEKO-TEX certification. Made in Europe.

100 x 180 cm

TR5, EDB, ETD, TRD

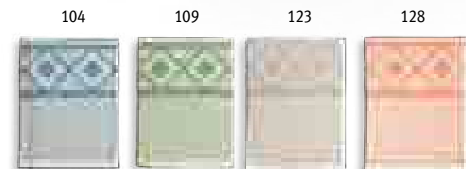

MADE IN EUROPE

Malek 99046

Multifunctional bath towel (350g/m²) made of light and resistant cotton (85%) and recycled cotton (15%). With OEKO-TEX certification. Made in Europe.

100 x 180 cm

TR5, EDB, ETD, TRD



104



104

118

Mekong 98319

PC sunglasses with translucent frames, category 3 mirrored lenses and UV400 protection. Complying with EN ISO 12312-1.

± 146 x 49 x 150 mm

➤ PDP



103



103

104

106

Niger 98317

PC sunglasses with category 3 mirrored lenses and UV400 protection. Complying with EN ISO 12312-1.

± 146 x 49 x 150 mm

➤ PDP



108



103

104

105

106

108

119

124

128

132

Celebes 98313

PC sunglasses. Category 3 lenses with UV400 protection, in compliance with EN ISO 12312-1 standards. Available in a wide range of colours.

± 146 x 49 x 150 mm

➤ PDP



103

Tobol 92853

Non-woven (80 g/m²) drawstring eyeglass pouch.

± 90 x 200 mm

➤ TRS TRD



Sanibel 98140

Bamboo sunglasses with mirrored lenses and UV400 protection. Supplied in a kraft paper pouch.

147 x 46 x 150 mm

LSR, PDP



160



Varadero 98324

Sunglasses with PP and bamboo frames. Category 3 mirrored lenses and UV400 protection. Complying with EN ISO 12312-1.

146 x 49 x 150 mm

PDP



103



Salema 98349

PET (100% rPET) sunglasses with category 3 lenses with UV400 protection, in compliance with EN ISO 12312-1. Supplied in a natural paper pouch.

146 x 49 x 145 mm

PDP



128



Beach accessories

Complement your trip to the beach and have everything you need to relax.



104



Peconic 98219

Translucent PVC inflatable ball, available in a wide range of colours.

⌘ Inflated: Ø245 mm

🔧 SCR, TRD, TRS



100

Paraguay 98264

Multi coloured inflatable beach ball in opaque PVC.

⌘ Inflated: Ø210 mm

🔧 SCR, TRD, TRS



128

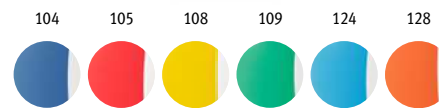

Cruise 98274

Inflatable beach ball with colourful stripes in opaque PVC.

⌘ Inflated: Ø210 mm

🔧 SCR, TRD, TRS



105

108

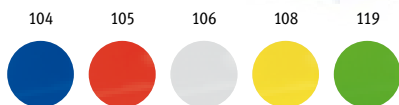

Timor 98293

Opaque PVC inflatable beach cushion, available in a wide range of colours.

⌘ 310 x 185 x 130 mm

🔧 SCR, TRD, TRS



128



Jurua 98458

190T foldable flying disc. Supplied in a pouch.

⌘ Ø250 mm | Pouch: 90 x 90 mm

🔧 TXP, TRD, TRS



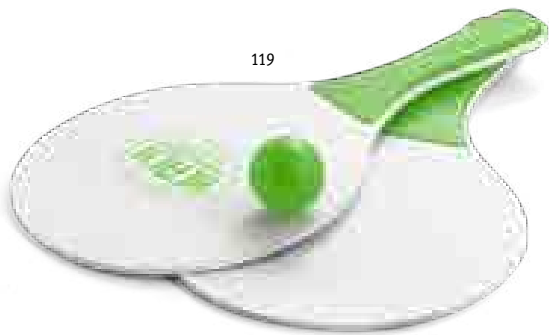

119

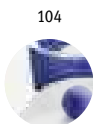

104

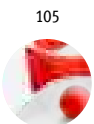

105



119

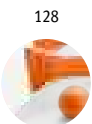

128

Filipinas 98035

MDF beach rackets with ball included.
Coloured handles and ball.

± Ø190 x 330 x 5 mm

✓ SCR



170



Tapia 98144

MDF beach rackets with ball included.
Supplied individually in a cotton bag.

± 330 x 190 x 5 mm

✓ TRD, LSR, SCR, TRS

Enjoy your water activities with our waterproof solutions



Volga 92670
Tarpaulin waterproof bag with click closure and adjustable strap. Practical and compact, this bag is easily folded to take up less space. Capacity up to 3.5/5 L. The bag is also waterproof.
∓ Ø150 x 320 mm
TXP



Purus 92671
Waterproof tarpaulin bag with click fastener and carabiner. Practical and compact, this bag is easy to fold to take up less space. Capacity up to 1.5/2.5 L. The bag is also waterproof.
∓ 175 x 325 mm
TXP



Egeu 98266
Waterproof phone bag in PVC with adjustable strap and spring lock. Clear on the front and matte white on the back. It allows the user to interact with the screen from the outside. The bag has an airtight closure and colourful flap with a self-adhesive hook and loop fastener.
∓ 95 x 240 mm
PDP, SCR

Enables touchscreen use



Platte 98316
Waterproof bag for tablets up to 9.7" in PVC. It allows the user to interact with the screen from the outside. The bag has a loop on top for an easier transport.
∓ 215 x 329 mm
SCR, TRD, TRS

SUN & RAIN





Rubber coated handle



Rubber coated handle



Campanela 99151
 190T compact pongee umbrella with rubber-coated handle. Automatic opening and closing. Foldable in 3 sections. Supplied in a pouch.
 ☒ Umbrella: Ø980 x 320 mm | Pouch: Ø50 x 240 mm
 ⚡ TRS TRD, TXP

Jacobs 99144
 190T compact pongee umbrella with rubber coated handle. This 3-section foldable umbrella is windproof and has automatic opening. Supplied in a pouch.
 ☒ Umbrella: Ø970 x 310 mm | Pouch: Ø50 x 250 mm
 ⚡ PDP TRD, TRS, TXP

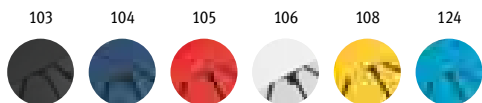

Maria 99138
 190T compact polyester umbrella, foldable in 3 sections with manual opening. Practical and lightweight umbrella, supplied in a pouch.
 ☒ Umbrella: Ø960 x 240 mm | Pouch: Ø40 x 215 mm
 ⚡ TRS TRD, TXP

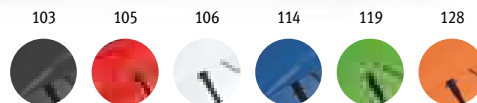

Tomas 99139
 190T polyester folding umbrella. The umbrella is foldable in 3 sections, has automatic opening. Available in a wide range of colours. Supplied in a pouch.
 ☒ Umbrella: Ø980 x 295 mm | Pouch: Ø45 x 245 mm
 ⚡ TRS TRD, TXP



Cimone 99041

190T PET (100% rPET) pongee umbrella, with fibreglass ribs and PP handle. Foldable umbrella in 3 sections with automatic opening and windproof. Supplied in bag.

Umbrella: Ø990 x 290 mm | Bag: Ø55 x 240 mm

TRS, DOM, TRD, TXP



River 99040

190T PET (100% rPET) pongee umbrella, with fibreglass ribs and wooden handle. Foldable umbrella in 3 sections, with automatic opening and closing and windproof. Supplied in bag.

Umbrella: Ø990 x 285 mm | Bag: Ø55 x 240 mm

TRS, TRD, TXP

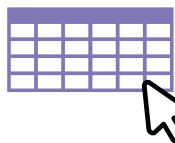

To learn more about other technical features, click here



Apolo 99149

PET (100% rPET) pongee umbrella with automatic opening, metal frame and shaft and wooden handle.

Ø1050 x 850 mm

TXP, TRD, TRS

For rainy or sunny days

Large umbrellas are a guarantee of protection and comfort.

104



103



103

104

106



Felipe 99130

190T pongee umbrella with fiberglass shaft and ribs and PP handle. This umbrella is windproof and has automatic opening. Product supplied in a pouch.

Umbrella: Ø1170 x 880 mm | Pouch: 85 x 725 mm

TRSR, TRD, TXP



Roberto 99109

190T polyester umbrella with wooden handle and manual opening.

Umbrella: Ø1270 x 965 mm

LSR, PDP, TRD, TRS, TXP

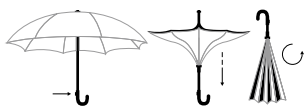

Reversible umbrella



104

104

113



Angela 99146

190T pongee reversible umbrella with double cover, metal handle and fiberglass ribs. This patented structure has manual opening and automatic closing.

Umbrella: Ø1050 x 790 mm

TRSR, TRD

105



105

114

119

**Alberta** 99145

Polyester umbrella with handle and ribs in coloured fibreglass. Umbrella with automatic opening.

∅1040 x 870 mm

TR5, TRD, TXP

104



103

104

**Albert** 99131

Pongee 190T umbrella with fibreglass shaft and ribs, and rubber coated handle. This umbrella is windproof and has automatic opening.

∅1030 x 890 mm

TR5, TRD, TXP

103

**Guil** 99126

190T polyester umbrella with rubber-coated handle and 12 rods, with automatic opening.

∅1100 x 900 mm

TXP, TRD, TR5

103

**Hedi** 99136

190T pongee umbrella with wooden handle and 16 ribs, with automatic opening.

∅1110 x 945 mm

LSR, PDP, TRD, TR5, TXP

105

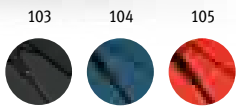

Michael 99134

190T polyester umbrella with rubber-coated handle and automatic opening.

∅1040 x 830 mm

TRS, TRD, TXP



108



Jenna 99137

190T polyester umbrella with EVA handle and automatic opening. Detailed contrast stitching on the umbrella and handle.

∅1040 x 825 mm

TRS, TRD, TXP



106



Nicholas 99143

Clear POE umbrella with automatic opening.

∅1000 x 815 mm

PDP, TXP



104

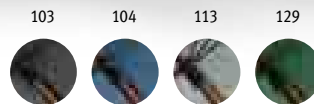

Betsey 99100

190T polyester umbrella with wooden shaft and handle. Manual opening.

∅1040 x 885 mm

TRS, TRD, TXP





Patti 99116

190T polyester umbrella with metal ribs and wooden handle and automatic opening mechanism. Available in a wide range of colours.

∅1040 x 885 mm

TXP, TRD, TRS

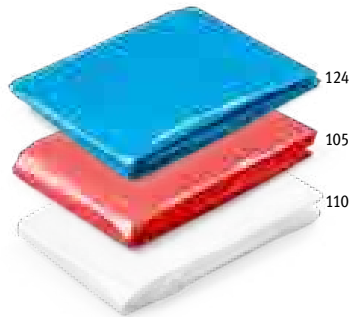
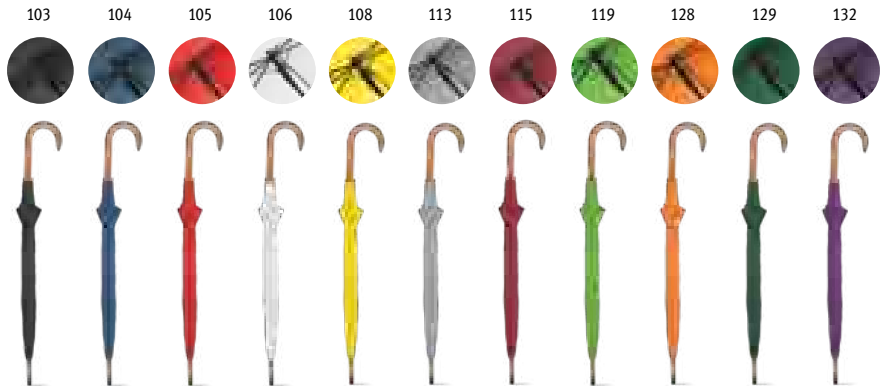

Sandra 99213

One size waterproof Poncho, available in a wide range of colours. Supplied in polybag.

1200 x 900 mm

STI

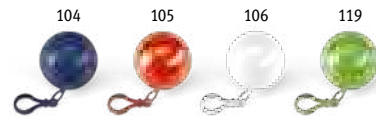

Isabel 99214

Waterproof poncho supplied in a ball-shaped packaging with keyring and carabiner.

∅63 mm | 1200 x 900 mm

PDP, DUV

Beanies that suit your needs

Comfortable fabrics for cold days.

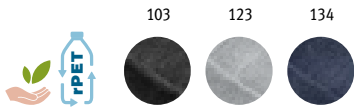

Carl 99038
 PET (100% rPET) double-layered soft knit unisex beanie. Foldable.
 ⚖️ Beanie: 180 x 235 mm (Folded) | Fold: 70 mm
 ⚡ **EDB**, ETD

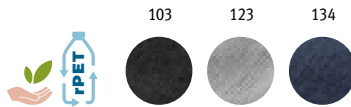

Hawk 99039
 PET (100% rPET) double-layered soft knit unisex beanie.
 ⚖️ 180 x 220 mm
 ⚡ **EDB**, ETD

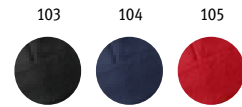

Tory 99018
 Polar fleece beanie (180 g/m²).
 ⚖️ 295 x 230 mm
 ⚡ **TRS**, EDB, ETD, TRD

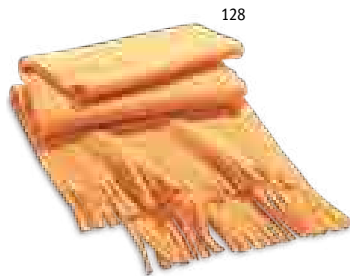

Touch tips

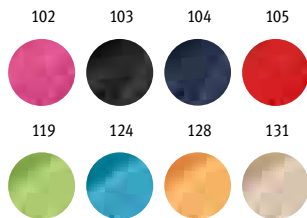

Thom 99016
 Pair of synthetic mesh gloves with touch tips.
 ⚖️ Size: 8"
 ⚡ **TRS**, TRD

Jason 99011
 Polar fleece scraf (200 g/m²) with strips on the ends, lightweight and practical to use. Available in a wide range of colours.
 ⚖️ 1500 x 250 mm
 ⚡ **TRS**, EDB, ETD, TRD

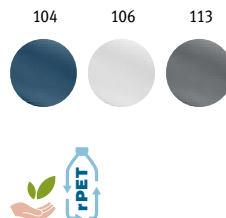

Kolkata 99080
 PET (100% rPET) multifunction bandana (120 g/m²).
 ⚖️ 250 x 500 mm
 ⚡ **TRS**, TRD

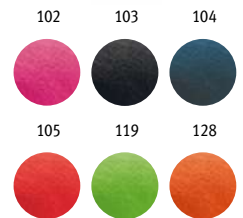

Charlotte 99021
 Multifunction microfiber bandana (130 g/m²).
 ⚖️ 250 x 470 mm
 ⚡ **TRS**, TRD



Explore with a clear conscience with our recycled cotton hat



Ryan 99090

Cap made of brushed cotton (65% recycled) with 6 panels and eyelets for ventilation (280 g/m²). Adjustable with metal buckle.

Size: 580 mm

TRD, EDB, ETD, TRS



103



104



105



131



104



103



104

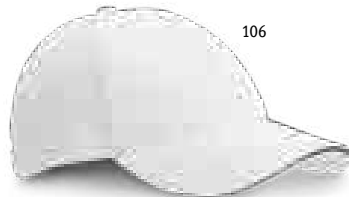

106

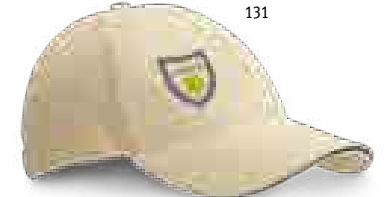

131



Phoebe 99457

Denim, cotton (60%) and polyester (40%) cap with 6 panels and eyelets (300 g/m²). Adjustable with a metal buckle.

Size: 580 mm

TRD, EDB, ETD, TRD



Christophe 99412

100% brushed cotton "sandwich" cap with 6 panels and eyelets. Adjustable with a metal buckle.

Size: 580 mm

TRD, EDB, ETD, TRD



Reflective elements



114



128



104



103

105

114

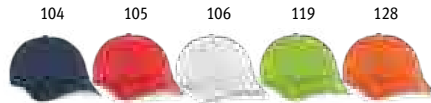

104

105

106

119

128



104

Nicola 99426

Polyester and mesh cap, adjustable with a plastic clasp.

Size: 580 mm

TRS EDB, ETD, TRD

Miuccia 99415

Polyester cap with 6 panels and eyelets. Adjustable closure with self-adhesive hook and loop fastener.

Size: 580 mm

TRS EDB, ETD, TRD



Jones 99418

Polyester cap with reflective elements, ventilation holes and adjustable closure with self-adhesive hook and loop fastener. Promotional product.

Size: 580 mm

TRS EDB, ETD, TRD



105



108



103

105

106

134



102

103

105

106

108

109

114

119

124

128

134

Claire 99568

Polyester sandwich cap with ventilation holes and adjustable self-adhesive hook and loop fastener. Available in a wide range of colours.

Size: 580 mm

TRS EDB, ETD, TRD

Campbel 99547

Polyester cap with eyelets and adjustable self-adhesive hook and loop fastener.

Size: 580 mm

TRS EDB, ETD, TRD



Rufai 99029

100% cotton cap with ventilation holes and adjustable self-adhesive hook and loop fastener. Available in a wide range of colours.

Size: 580 mm
 TRS EDB, ETD, TRD



Bailey 99410

100% cotton canvas cap with eyelets and adjustable self-adhesive hook and loop fastener.

Size: 580 mm
 TRS EDB, ETD, TRD



Jonathan 99453

Polyester panama in a single colour. Ideal to protect yourself from the hottest days. Available in a wide range of colours.

Size: 580 mm
 TRS EDB, ETD, TRD

Joseph 99572

Cotton canvas and polyester bucket hat.

Size: 580 mm
 TRS EDB, ETD, TRD

Blass 99409

100% polyester safari hat with eyelets and adjustable string.

Size: 580 mm
 TRS EDB, ETD, TRD

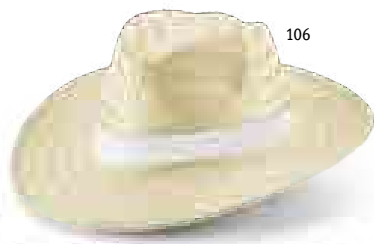

106

Edward Rib 99085

Natural straw hat with sublimated ribbon. The price includes personalisation on the ribbon.

Size: 580 mm

SUB



103

Edward Poli 99084

Natural straw hat with polyester ribbon. For orders without personalisation the ribbon is supplied separately from the hat.

Size: 580 mm

TRS, TRD



103

106

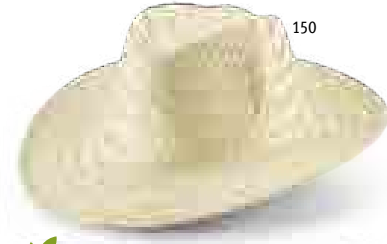

150



Edward 99423

Natural straw hat.

Size: 580 mm

X

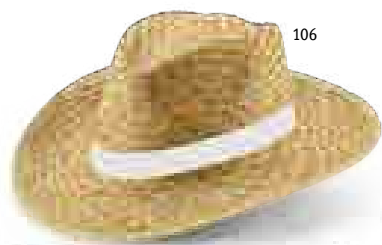

106

Jean Rib 99083

Natural straw hat with sublimated ribbon. The price includes personalisation on the ribbon.

Size: 580 mm

SUB



106

Jean Poli 99082

Natural straw hat with polyester ribbon. For orders without personalisation the ribbon is supplied separately from the hat.

Size: 580 mm

TRS, TRD



103

106

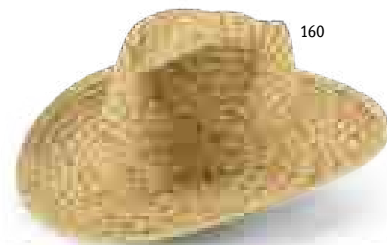

160



Jean 99419

Natural straw hat.

Size: 580 mm

X



114



128



102 103 105 106

114 119 128

Manolo Poli 99086

Hat in PP (available in several colours) with white polyester ribbon. For orders without personalisation the ribbon is supplied separately from the hat.

Size: 580 mm

TRS, TRD



102 103 105 106

114 119 128

Manolo 99427

PP hat (ribbon not included). Available in a wide range of colours.

Size: 580 mm

X



103 105 106

114 119 124 128

Burton 99428

100% polyester ribbon, available in a wide range of colours.

650 x 24 mm

TRS, TRD

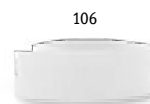

106

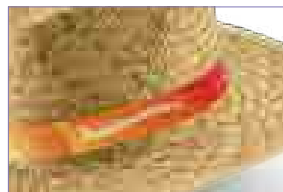

Magaley 99458

Sublimated polyester ribbon to be applied on a hat.

650 x 20 mm

SUB



103 104

105 119 131

Diane 99449

Non-woven ribbon (80 g/m²), available in a wide range of colours.

650 x 22 mm

TRS, TRD

TEXTILE





TH Clothes® - The brand

TH Clothes® was created in 2006. The objective was to invest and provide innovative products of certified quality, based on sophisticated designs, colour diversity and an efficient and sustainable use of the resources applied. The brand's main premise is customer satisfaction, without neglecting social responsibility and commitment to quality. All products are OEKO-TEX® certified, since they comply with all the criteria required by STANDARD 100 by OEKO-TEX®. This certification is extremely important, since it guarantees to both customers and users the product safety.



THC Ankara



Tubular t-shirt for men with a regular cut in jersey 100% cotton (190 g/m²) with carded cotton yarn (colour 183: 90% cotton/10% viscose). Features a 1x1 rib collar with jersey reinforcement ribbon and double seam on sleeves and hemline

📏 Sizes: XS, S, M, L, XL, XXL

- 🔪 30109: DTG, EDB, ETD, TRD, TRS, TXP
- 🔪 30110: TRS, EDB, ETD, TRD, TXP

THC Ankara Women



100% cotton jersey Women's fitted T-shirt (190 g/m²) with carded cotton yarn (colour 183: 90% cotton and 10% viscose). Features a thin jersey collar with satin ribbon reinforcement. Piece cut and sewn with double seam sleeve cuff and hemline.

📏 Sizes: S, M, L, XL, XXL

- 🔪 30113: DTG, EDB, ETD, TRD, TRS, TXP
- 🔪 30114: TRS, EDB, ETD, TRD, TXP

THC Luanda



Tubular t-shirt for men with a regular cut in jersey 100% cotton (150 g/m²) with carded cotton yarn (colour 183: 90% cotton/10% viscose). Features a 1x1 rib collar with jersey reinforcement ribbon and double seam on sleeves and hemline.

📏 Sizes: XS, S, M, L, XL, XXL

- 🔪 30101: TRS, DTG, TRD, TXP
- 🔪 30102: TRS, TRD, TXP



Textile manufacture responsible and with quality assurance. Tested for use of nocive substances according to Oeko-Tex® Standard 100.

30109



30110



30113



30114



30101



30102



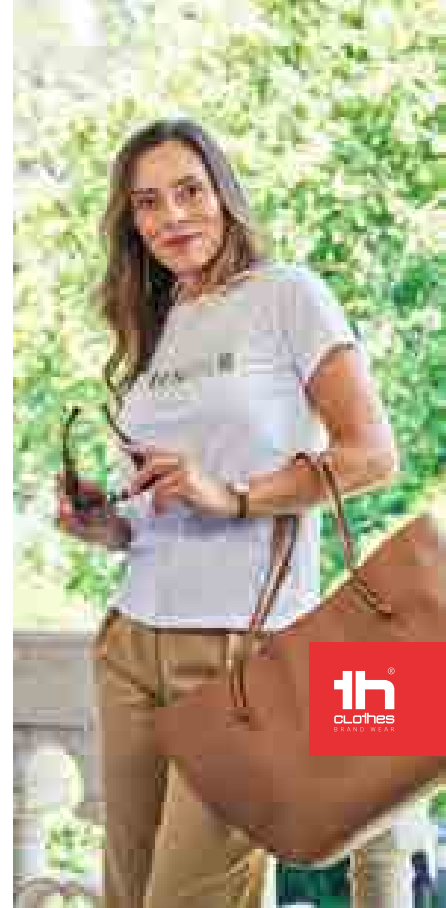

THC Fair



T-shirt in 100% cotton jersey (150 g/m²) sourced from sustainable practices. 1x1 rib collar with jersey reinforcement. Double stitching on sleeves and hem. T-shirt in tubular format.

↓ Sizes: XS, S, M, L, XL, XXL

⚡ 30279: **TXP**, TRD, TRS

⚡ 30277: **TXP**, TRD, TRS

THC Fair Small



T-shirt in 100% cotton jersey (150 g/m²) sourced from sustainable practices. 1x1 rib collar with jersey reinforcement. Double stitching on sleeves and bottom. Environmentally friendly product.

↓ Sizes: XXXS, XXS

⚡ 30289: **TXP**, TRD, TRS

⚡ 30269: **TXP**, TRD, TRS

THC Sofia



Women's fitted T-shirt in 100% cotton jersey knit (150 g/m²) with carded cotton yarn (colour 183: 90% cotton/10% viscose; colour 196: 98% cotton/2% viscose). Features a thin double collar in jersey reinforced by a satin bias tape. Cut and sewn garment with double stitched sleeve and hemline.

↓ Sizes: S, M, L, XL, XXL

⚡ 30105: **DTG**, TRD, TRS, TXP

⚡ 30106: **TRS**, TRD, TXP

THC Sofia Regular



Regular cut T-shirt for women (350 g/m²) with enzymatic treatment in jersey fabric (100% cotton using sustainable farming practices). It has a thin double collar in jersey with a satin reinforcement ribbon. Cut and sewn with double stitching on the sleeves and bottom.

↓ Sizes: XS, S, M, L, XL, XXL

⚡ 30316: **TXP**, DTG, TRD, TRS

⚡ 30317: **TRS**, TRD, TXP

30279

106

30289

106

30105

106

30316

106

30277

103 104 124 152 169

30269

103 104 124 152 169

30106

102 103 104 105 108 109 111 112
113 114 115 118 119 121 123 128
132 141 142 144 146 148 149 154
158 164 168 178 183 184 196 208

30317

103 104 105 114 183



THC Ibiza



100% cotton men's sleeveless jersey (140 g/m²) with carded cotton yarn (colours: 194, 195 and 199: 60% cotton/40% polyester and colour 183: 90% cotton/10% viscose). Wide armholes and round collar, with bias tape on the armholes and neckline. Piece cut and sewn with double seam at the hemline

📏 Sizes: XS, S, M, L, XL, XXL

🔪 30121: DTG, TRD, TRS, TXP
🔪 30122: TRS, TRD, TXP

30121

106

30122

103

THC Tirana



Sleeveless T-shirt for women in 100% cotton jersey knit (160 g/m²) with carded cotton yarn. Round collar and "T" shaped back. Cut and sewn garment with double stitched hem and bias on the armholes and neckline.

📏 Sizes: S, M, L, XL, XXL

🔪 30119: DTG, TRD, TRS, TXP
🔪 30120: TRS, TRD, TXP

30119

106

30120

103 178

THC Move



Technical T-shirt in 100% polyester pique mesh (150 g/m²). Regular cut with breathable fabric and raglan sleeves. Double stitching on sleeves and bottom.

📏 Sizes: XS, S, M, L, XL, XXL

🔪 30274: TRS, TRD
🔪 30273: TRS, TRD

30274

106

30273

103 105 114 123 134
138 139 188 198

MADE IN EUROPE

THC Tube



T-shirt in jersey (190 g/m²) polyester (90%) and elastane (10%), T-shirt with 1x1 rib collar. Double stitching on sleeves and bottom. Product supplied in a cardboard tube.

📏 Sizes: XS, S, M, L, XL

🔪 30282: TRS, TRD
🔪 30281: TRS, TRD

30282

106

30281

103 108 122 124 152 154 169



THC Run



Mid-calf sports sock made of 95% polyester and 5% spandex (100 g/m²). Reinforced mesh in the sole and ankle areas of the foot, ensuring greater comfort when playing sports. Contains mesh for ventilation and elastic at the cuffs.

Size: 36, 39, 40, 44

- 30304: **TRS**, EDB, ETD, TRD
- 30303: **TRS**, EDB, ETD, TRD

30304

106

30303

103 105 114 134 139

THC Match



Adult sports shorts in 100% recycled polyester pique mesh (150 g/m²). The breathable fabric offers greater comfort during outdoor activities. Elastic waistband with pleats and drawstring in the color of the shorts. Double-stitched at the hem of the garment.

Size: S, M, L, XL, XXL

- 30299: **TRS**, TRD
- 30298: **TRS**, TRD

30299

106

30298

103 105 114 134 139

THC Sprint



Enzyme-treated sweatpants (unisex) in french terry (70% cotton using sustainable farming practices) and 30% recycled polyester (300 g/m²). 1x1 rib elastic waistband with drawstrings in the same colour as the pants and two side pockets with invisible zippers and reinforced seams. The bottom of the tracksuit pants are also made of 1x1 rib.

Size: XS, S, M, L, XL, XXL

- 30308: **TRS**, EDB, ETD, TRD
- 30307: **TRS**, EDB, ETD, TRD

30308

106

30307

103 134 183



THC Monaco Women



100% carded cotton (240 g/m²) short-sleeved pique women polo. Regular cut with collar and ribbon sleeves and pique collar reinforcement. Reinforced collar with 2 matching coloured buttons (extra button in the inner seam). Piece cut and sewn with small side openings at the bottom of the polo. The visible label is removable.

📏 Sizes: S, M, L, XL, XXL

- 🔪 30261: **TXP**, DTG, EDB, ETD, TRD, TRS
- 🔪 30262: **TXP**, EDB, ETD, TRD, TRS

30261

106

30262



THC Monaco



Short-sleeved men's polo made 100% carded cotton (240 g/m²) (colour: 183: 85% cotton/15% viscose). Regular cut with collar and ribbon sleeves and pique collar reinforcement. Reinforced collar with 3 matching colour buttons (extra button inserted in the inner seam). Piece cut and sewn with small side openings at the bottom of the polo. The visible label is removable.

📏 Sizes: S, M, L, XL, XXL

- 🔪 30187: **DTG**, EDB, ETD, TRD, TRS, TXP
- 🔪 30188: **TRS**, EDB, ETD, TRD, TXP

30187

106

30188



THC Eve



100% carded cotton pique women's short sleeve polo (195 g/m²) (colour 183: 85% cotton/15% viscose). Features a rib collar and sleeves, the collar is reinforced with pique ribbon. On the front, next to the collar, there are four matching colour buttons (extra button inserted in the inner seam). Piece cut and sewn.

📏 Sizes: S, M, L, XL, XXL

- 🔪 30134: **DTG**, EDB, ETD, TRD, TRS, TXP
- 🔪 30135: **TRS**, EDB, ETD, TRD, TXP

30134

106

30135



THC Adam



100% cotton carded pique mesh short-sleeved men's polo (195 g/m²) (colour 183: 85% cotton/15% viscose). With a regular fit, this polo has rib collar and sleeves. The collar is reinforced with pique ribbon. On the front, next to the collar, there are three matching colour buttons (extra button inserted in the inner seam). Piece cut and sewn with small side vents at the hem of the polo.

📏 Sizes: S, M, L, XL, XXL

- 🔪 30130: **DTG**, EDB, ETD, TRD, TRS, TXP
- 🔪 30131: **TRS**, EDB, ETD, TRD, TXP

30130

106

30131



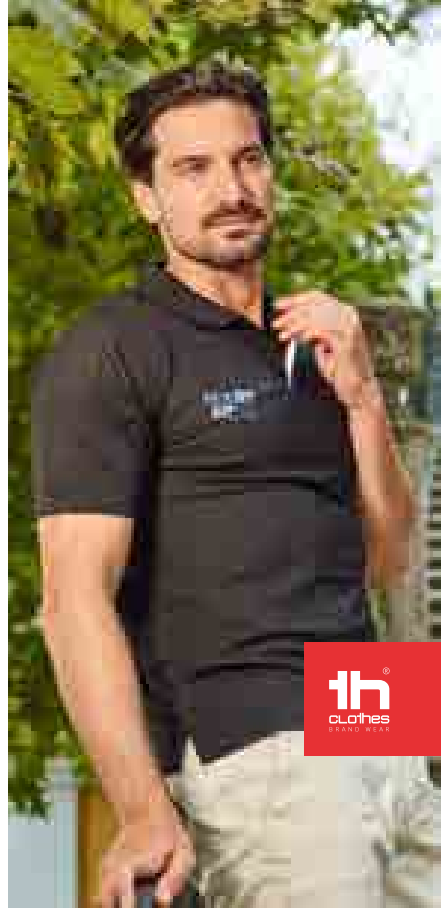

THC Rome



Short-sleeved bicolour polo for men in piqué 100% cotton carded (210 g/m²) (colour: 183: 85% cotton/15% viscose). Two-colour contrast on the collar, sleeve and placket. Features a collar and cuffs in Rib. Reinforced placket with 3 contrasting colour buttons (extra button inserted in the inner side seam). Fitted waist and small side vents at the hemline of the polo.

📏 Sizes: S, M, L, XL, XXL

- 🔪 30136: **DTG**, EDB, ETD, TRD, TRS, TXP
- 🔪 30137: **TRS**, EDB, ETD, TRD, TXP

30136

106

30137

103 105 113 114 134 183

THC Rome Women



Short-sleeved bicolour polo for women in 100% carded cotton pique (210 g/m²) (colour: 183: 85% cotton/15% viscose). Two-colour contrast on the collar, sleeve and placket. Features a collar and cuffs in Rib. Reinforced placket with 3 contrasting colour buttons (extra button inserted in the inner side seam). Fitted waist and small side vents at the hemline of the polo.

📏 Sizes: S, M, L, XL, XXL

- 🔪 30138: **DTG**, EDB, ETD, TRD, TRS, TXP
- 🔪 30139: **TRS**, EDB, ETD, TRD, TXP

30138

106

30139

103 105 113 114 134 183

THC Dynamic Women



Short-sleeved technical polo for women in 100% recycled polyester piqué knit (180 g/m²). This polo shirt has a 1x1 rib collar and double stitching on the sleeves and bottom. Reinforced placket with 3 colored buttons finished in white (except for colour 106 which is contrasted with black). Piece cut and sewn with small side openings at the bottom of the polo and finished in white (except for colour 106 which is contrasted with black).

📏 Sizes: XS, S, M, L, XL, XXL

- 🔪 30293: **TXP**, EDB, ETD, TRD, TRS
- 🔪 30292: **TXP**, EDB, ETD, TRD, TRS

30293

106

30292

103 105 114 134 139

THC Dynamic



Men's short-sleeved technical polo shirt in 100% recycled polyester piqué knit (180 g/m²). This polo shirt has a 1x1 rib collar and double stitching on the sleeves and bottom. Reinforced placket with 3 coloured buttons finished in white (except for colour 106 which is contrasted with black). Piece cut and sewn with small side vents at the bottom of the polo shirt and finished in white (except for colour 106 which is contrasted with black).

📏 Sizes: S, M, L, XL, XXL, 3XL

- 🔪 30291: **TRS**, EDB, ETD, TRD, TXP
- 🔪 30290: **TRS**, EDB, ETD, TRD, TXP

30291

106

30290

103 105 114 134 139



th
clothes
BRAND WEAR



THC Bern Women



Long-sleeved polo for women in piqué 100% carded cotton (210 g/m²) (colour 183: 85% cotton/15% viscose). Rib collar reinforced with piqué knit ribbon. Features a reinforced placket with 4 matching colour buttons (extra button inserted in the inner seam). Piece cut and sewn with double seam sleeves. The visible label is removable.

📏 Sizes: S, M, L, XL, XXL

🔪 30144: **DTG**, EDB, ETD, TRD, TRS, TXP

🔪 30145: **TRS**, EDB, ETD, TRD, TXP

30144

106

30145

102 103 104 105 113
114 115 183 184

THC Bern



Long-sleeved polo for men in piqué 100% carded cotton (210 g/m²) (colour 183: 85% cotton/15% viscose). Regular cut polo with rib collar and cuffs, the collar being reinforced with piqué knit ribbon. Contains a reinforced collar with 3 matching colour buttons (extra button inserted in the inner seam). Piece cut and sewn with side vents at the hem. The visible label is removable.

📏 Sizes: S, M, L, XL, XXL

🔪 30140: **DTG**, EDB, ETD, TRD, TRS, TXP

🔪 30141: **TRS**, EDB, ETD, TRD, TXP

30140

106

30141

103 104 105 111 113
114 115 128 183 184

THC Milan



Pullover with "V" neckline for men 70% cotton and 30% polyamide (220 g/m²). Features a collar, cuffs and lower part in rib and inset sleeves

📏 Sizes: S, M, L, XL, XXL

🔪 **EDB**, ETD

30149

103 134

THC Milan Women



Pullover with "V" neckline for women 70% cotton and 30% polyamide (220 g/m²). Contains a collar, cuffs and lower part in rib and inset sleeves.

📏 Sizes: S, M, L, XL, XXL

🔪 **EDB**, ETD

30150

103 134



THC Tokyo



Long sleeve oxford shirt for men in 70% cotton and 30% polyester (130 g/m²). Contains adjustable cuffs with 2 buttons, sleeve with 2 pleats and chest pocket on the left side. Collar with 2 buttons and placket with 7 pearl coloured buttons (except black).

📏 Sizes: S, M, L, XL, XXL

- 🔪 30196: **DTG**, EDB, ETD, TRD, TRS, TXP
- 🔪 30153: **TRS**, EDB, ETD, TRD, TXP

30196

106

30153

103 113 115 124

THC Tokyo Women



Long-sleeved oxford shirt for women in 70% cotton and 30% polyester (130 g/m²). Contains adjustable cuffs with 2 buttons and sleeve with 1 pleat. Fitted shirt with 2 darts on the front and back, and placket with 7 pearl coloured buttons.

📏 Sizes: S, M, L, XL, XXL

- 🔪 30197: **DTG**, EDB, ETD, TRD, TRS, TXP
- 🔪 30154: **TRS**, EDB, ETD, TRD, TXP

30197

106

30154

103 113 115 124

THC Paris Women



Long-sleeved shirt for women in 68% cotton, 28% polyamide and 4% elastane (115 g/m²). Long sleeve with 1 pleat and adjustable cuffs with 1 button. Fitted waist with 2 darts on the back and placket with 7 matching colour buttons.

📏 Sizes: S, M, L, XL, XXL

- 🔪 30195: **DTG**, EDB, ETD, TRD, TRS, TXP
- 🔪 30152: **TRS**, EDB, ETD, TRD, TXP

30195

106

30152

103 113 115 124

THC Paris



Long-sleeved men's shirt in 68% cotton, 28% polyamide and 4% elastane (115 g/m²). Long sleeve with 1 pleat and adjustable cuffs with 2 buttons. Placket with 7 buttons in matching colour.

📏 Sizes: S, M, L, XL, XXL

- 🔪 30194: **DTG**, EDB, ETD, TRD, TRS, TXP
- 🔪 30151: **TRS**, EDB, ETD, TRD, TXP

30194

106

30151

103 113 115 124



THC Bucharest



Long-sleeved men's t-shirt 100% cotton jersey (150 g/m²) with carded cotton yarn (colours: 194: 60% cotton/40% polyester; colour 183: 90% cotton/10% viscose). Rib collar 1x1 and jersey reinforcement ribbon. Tubular T-shirt with regular cut and double seam on the sleeves and hemline

📏 Sizes: S, M, L, XL, XXL

🔪 30123: **DTG** TRD, TRS, TXP

🔪 30124: **TRS** TRD, TXP

30123

106

30124

103 104 105 114
134 141 159 183 195

THC Bucharest Women



Long-sleeved fitted women's jersey shirt 100% cotton (150 g/m²) with carded cotton yarn (colours: 194, 195: 60% cotton/40% polyester; colour 183: 90% cotton/10% viscose). Modern cut with collar with jersey reinforcement band. Cut and sewn piece with double seam on sleeves and hemline.

📏 Sizes: S, M, L, XL, XXL

🔪 30125: **DTG** TRD, TRS, TXP

🔪 30126: **TRS** TRD, TXP

30125

106

30126

103 104 105 114 134
141 159 183 194 195

THC Delta



Sweatshirt (unisex) in 50% cotton and 50% polyester (300 g/m²) with carded interior. Features a double and rib seam on collar, cuffs and waistband. The collar includes reinforcement ribbon.

📏 Sizes: S, M, L, XL, XXL

🔪 30202: **DTG** EDB, ETD, TRD, TRS, TXP

🔪 30159: **TRS** EDB, ETD, TRD, TXP

30202

106

30159

103 105 109 113 114 115
121 128 129 134 142 149
168 169 178 183

THC Phoenix



Hooded sweatshirt (unisex) in 50% cotton and 50% polyester (320 g/m²) with carded interior. The hood includes eyelets and fastening cord in matching colour. Sweatshirt with marsupial pocket and 1x1 Rib on the cuffs and waistband.

📏 Sizes: XS, S, M, L, XL, XXL

🔪 30203: **DTG** EDB, ETD, TRD, TRS, TXP

🔪 30160: **TRS** EDB, ETD, TRD, TXP

30203

106

30160

103 105 109 113 114 115 118
121 128 132 134 142 148 149
152 158 164 168 169 178 183 196



THC Moscow



Sweatshirt (unisex) 50% cotton and 50% polyester (320 g/m²) with carded interior. Features rib 1x1 cuffs and waistband, marsupial pocket and hood with contrasting colour strings.

📏 Sizes: S, M, L, XL, XXL

🔪 **TRS**, EDB, ETD, TRD, TXP

THC Karachi



Cotton (80%) and recycled polyester (20%) sweatshirt (280g/m²). Environmentally friendly product.

📏 Sizes: XS, S, M, L, XL, XXL

🔪 30285: **TXP**, EDB, ETD, TRD, TRS

🔪 30283: **TXP**, EDB, ETD, TRD, TRS

THC Amsterdam



50% cotton and 50% polyester men's sweatshirt (320 g/m²) with carded interior. The hood is lined and contains colour cord closure. The front area has two marsupial pockets with plastic cover closure. Piece with cuffs and ribbon waistband.

📏 Sizes: S, M, L, XL, XXL

🔪 30256: **TRS**, EDB, ETD, TRD, TXP

🔪 30161: **TRS**, EDB, ETD, TRD, TXP

THC Amsterdam Women



50% cotton and 50% polyester women's sweatshirt (320 g/m²) with carded interior. The hood is lined and contains colour cord closure. The front area has two marsupial pockets with plastic cover closure. Piece with cuffs and ribbon waistband.

📏 Sizes: S, M, L, XL, XXL

🔪 30257: **TRS**, EDB, ETD, TRD, TXP

🔪 30162: **TRS**, EDB, ETD, TRD, TXP

30285



30256



30257



30189



30283



30161



30162





th
clothes
BRAND WEAR



THC Budapest



Sweatshirt (unisex) 50% cotton and 50% polyester (320 g/m²) with carded interior. Features ribbon cuffs and waistband and 1/4 coloured zip.

⚡ Sizes: S, M, L, XL, XXL

🔪 TRS, EDB, ETD, TRD, TXP

THC Vienna



Fleece (unisex) in 100% polyester (260 g/m²) with 1/4 zip closure. Contains elastic band on the sleeves and zip guard for extra comfort.

⚡ Sizes: S, M, L, XL, XXL

🔪 EDB, ETD

THC Helsinki Women



100% polyester women's fitted fleece jacket (260 g/m²) with coloured zip and zip guard for greater comfort. Contains side pockets and elastic band on sleeves.

⚡ Sizes: S, M, L, XL, XXL

🔪 EDB, ETD

THC Helsinki



100% polyester men's fleece jacket (260 g/m²) with coloured zip and zip guard for greater comfort. Contains side pockets and elastic cuffs.

⚡ Sizes: S, M, L, XL, XXL

🔪 EDB, ETD

30163

103 105 114 134 173 183 194

30166

103 105 113 114 134

30165

103 105 113 114 129 134

30164

103 105 113 114 129 134



THC Cloud



Padded vest (unisex) in 100% recycled nylon ripstop (350 g/m²), the interior is lined in 100% recycled nylon taffeta (350 g/m²) for greater comfort when wearing it. Front opening with YKK® zipper - a brand that uses modern equipment with high quality control - and handle. It has two front pockets with zippers and pullers and two inside pockets with adhesive zippers. On the lower back there is a zippered access for easy personalization.

📏 Sizes: XS, S, M, L, XL, XXL, 3XL

🔪 EDB, ETD

30315



THC Baku



Unisex softshell vest in 96% polyester and 4% elastane with two layers (280 g/m²). Water resistant vest with a back length longer than the front. Contains three pockets, two side pockets with zip, and a double welted chest pocket. Customisation area with easy access.

📏 Sizes: S, M, L, XL, XXL, 3XL

🔪 TRS, EDB, ETD, TRD

30252



THC Pixel



Polyester (65%) and cotton (35%) multi-pocket vest (200 g/m²) with water repellent treatment. Suitable for reporters and other field professions.

📏 Sizes: S, M, L, XL, XXL

🔪 TXP, TRD, TRS

30270



THC Stockholm



Men's padded work vest in 100% oxford polyester with an acrylic coating (170 g/m²), lined in 100% taffeta polyester (65 g/m²). Fleece lined collar and elastic sides for better fit. Contains 6 pockets: 5 front pockets, including 2 with inner zip plus 1 for mobile phone, and 1 inside pocket. Zipped access at the back for easy customisation.

📏 Sizes: S, M, L, XL, XXL, 3XL

🔪 TRS, TRD

30177





THC Cargo



Work trousers (200 g/m²) in ripstop polyester (65%) and cotton (35%). Contains 8 pockets: 2 side pockets with small pocket, 2 back pockets with snap buttons and 2 pockets on the side of the leg with snap. Elasticated waist system.

📏 Sizes: S, M, L, XL, XXL

🔪 TRS, TRD

THC Tallinn



98% cotton and 2% elastane trousers (240 g/m²). Contains 6 pockets: 2 side pockets with zip closure, 2 front pockets and 2 back pockets. Waist with elastic on the sides.

📏 Sizes: S, M, L, XL, XXL, 3XL

🔪 TRS, TRD

THC Bratislava



98% cotton and 2% elastane jacket (240 g/m²). Modern cut, it contains 2 darts on the back and elastic on the wrist and waist. Buttoning done through snap buttons. Includes 2 back pockets and 1 chest pocket.

📏 Sizes: S, M, L, XL, XXL, 3XL

🔪 TRS, TRD, TXP

THC Zagreb Work



High-visibility softshell jacket (class III) in 100% polyester (320 g/m²), with three layers, a detachable hood and water-resistant coating. Softshell jacket with fleece lining and TPU coating. Contains 2 front pockets and a diagonal chest pocket, both with zips. Adjustable cuffs with self-adhesive hook and loop fastener. Removable hood with drawstring and loop fastener to attach to the collar. Rounded hem on the back.

📏 Sizes: S, M, L, XL, XXL

🔪 TRS, TRD

30272



30247



30248



30182





THC Astana



Unisex padded jacket (exterior: 170 g/m² 100% polyester oxford with acrylic coating; filling: 75 g/m² 100% polyester; interior: 65 g/m² 100% polyester taffeta). Convertible to vest, with removable zippered sleeves. Contains a collar lined with polar mesh and three pockets with zipper. Zipped access at the back for easy customisation.

📏 Sizes: S, M, L, XL, XXL, 3XL

🔪 TRS, TRD

30251



THC Liubliana



Padded parka (unisex) 100% polyester (exterior: 240 g/m² 100% polyester pongee 240 and waterproof PVC coating; interior: 65 g/m² 100% polyester taffeta; filling: 100% polyester 80 g/m²). Collar lined with black polar mesh fastened with a self-adhesive hook and loop closure. Foldable collar hood, adjustable with black stoppers. Opening with flap, coloured zip, self-adhesive hook and loop fastener and snap buttons in black. Features 2 outer pockets with flap and 2 inner pockets (1 for mobile phone) with hook and loop fastener. Inner 2x2 ribbed mesh cuffs and adjustable outer cuffs with adjustable hook and loop straps. Thermo-sealed seams. Zipped lower back access for easy customisation.

📏 Sizes: XS, S, M, L, XL, XXL

🔪 EDB, ETD

30183



THC Shield Women



Women's hooded jacket in 100% recycled nylon ripstop (350 g/m²), the inside is lined in 100% recycled nylon taffeta (350 g/m²) for greater comfort when wearing it. The hood is padded and has different features: an elastic band, two snap buttons and a zipper that can be removed. Front opening with YKK® zipper - a brand that uses modern equipment with high quality control - and puller. It has two front pockets with zippers and pullers and two inside pockets with adhesive zippers. On the lower back there is a zippered access for easy personalization.

📏 Sizes: XS, S, M, L, XL, XXL

🔪 EDB, ETD

30314



THC Shield



Men's hooded jacket in 100% recycled nylon ripstop (350 g/m²) with a 100% recycled nylon taffeta (350 g/m²) lined interior for greater wearing comfort. The hood is padded and has different functions: elastic band, two snap buttons and a zipper that can be removed. Front opening with YKK® zipper - a brand that uses modern equipment with high quality control - and puller. It has two front pockets with zippers and pullers and two inside pockets with adhesive zippers. On the lower back there is a zippered access for easy personalization.

📏 Sizes: S, M, L, XL, XXL, 3XL

🔪 EDB, ETD

30313





THC Zagreb



Softshell men's jacket in 96% polyester and 4% elastane (280 g/m²), with two layers, removable hood and water resistant coating. Fleece lined jacket with 2 front pockets and diagonal chest pocket, all with zips. Adjustable cuffs with self-adhesive hook and loop fastener. Removable hood with drawstring and self adhesive hook and loop fastener to attach to the collar. Rounded hem on the back.

📏 Sizes: S, M, L, XL, XXL

🔪 TRS, EDB, ETD, TRD

THC Zagreb Women



Softshell vest for women in 96% polyester and 4% elastane (280 g/m²), with two layers, removable hood and water-resistant coating. Lined jacket with 2 front pockets and diagonal chest pocket, all with zips. Adjustable cuffs with self-adhesive hook and loop fastener. Removable hood with drawstring and self-adhesive hook and loop fastener to attach to the collar. Rounded hem on the back.

📏 Sizes: S, M, L, XL, XXL

🔪 TRS, EDB, ETD, TRD

THC Skopje



Hooded jacket for men in 300T taffeta (95% polyester and 5% elastane) (280 g/m²). Modern cut with flattering seam on the chest. Contains hood with stoppers and inner pockets. Easy customisation area above the chest.

📏 Sizes: S, M, L, XL, XXL

🔪 TRS, TRD

THC Dubliners



Waterproof windbreaker (Unisex) in 100% recycled nylon taffeta fabric (65 g/m²). Front opening with YKK® zipper - a brand that uses modern equipment and high quality control. The hood is lined with mesh and has drawstrings for tightening. It has eyelets for easy ventilation, elastic fastening with stoppers at the and bottom and zippered side pockets.

📏 Sizes: XS, S, M, L, XL, XXL

🔪 TXP

30180



30181



30246



30300





THC Sprint Kids



Children's tracksuit pants with enzymatic treatment, in french terry (70% cotton using sustainable farming practices) and 30% recycled polyester (300 g/m²). 1x1 rib elastic waistband with drawstrings in the colour of the item and two side pockets with invisible zippers and reinforced seams. The bottom of the tracksuit pants are also made of 1x1 rib.

↕ Sizes: 4, 6, 8, 10, 12

🔪 30310: **TRS**, EDB, ETD, TRD

🔪 30309: **TRS**, EDB, ETD, TRD

30310

106

30309

103 134 183

THC Match Kids



Children's sports shorts in 100% recycled polyester pique mesh (150 g/m²). Breathable fabric for greater comfort during outdoor activities. Elastic waistband with pleats and drawstring in the colour of the shorts. Double-stitched at the hem of the garment.

↕ Sizes: 4, 6, 8, 10, 12

🔪 30297: **TRS**, TRD

🔪 30296: **TRS**, TRD

30297

106

30296

103 105 114 134 139

THC Run Kids



Medium-length children's sports sock made of 95% polyester and 5% spandex (100 g/m²). Reinforced mesh in the sole and ankle areas of the foot, ensuring greater comfort when playing sports. Contains ventilation mesh and elastic at the cuffs.

↕ Sizes: 30, 35

🔪 30306: **TRS**, TRD

🔪 30305: **TRS**, TRD

30306

106

30305

103 105 114 134 139

THC Dubliners Kids



Waterproof windbreaker for children (Unisex) in 100% recycled nylon taffeta fabric (65 g/m²). Front opening with YKK® zipper - a brand that uses modern equipment and high quality control. The hood is lined with mesh and has drawstrings for tightening. It has eyelets for easy ventilation, elastic fastening with stoppers at the bottom and zippered side pockets

↕ Sizes: 4, 6, 8, 10, 12

🔪 **TXP**

30301

103 104 105 114 139



THC Adam Kids

30172



106

100% cotton piqué knit Kids' (unisex) short-sleeved polo (195 g/m²). Features a rib collar and sleeves and the collar is reinforced with piqué ribbon. On the front, next to the collar, there are three matching colour buttons (extra button inserted in the inner seam) and a reinforced collar. Piece cut and sewn with small side vents at the hem.

📏 Sizes: 2, 4, 6, 8, 10, 12

🔪 30172: **DTG**, EDB, ETD, TRD, TRS, TXP
 🔪 30173: **TRS**, EDB, ETD, TRD, TXP

30173



THC Quito

30168



106

Kids' T-shirt (unisex) in 100% carded cotton jersey (150 g/m²). Contains a 1x1 Rib collar with jersey reinforcement bias tape. Cut and sewn garment, double stitched on the sleeves and hemline

📏 Sizes: 2, 4, 6, 8, 10, 12

🔪 30168: **DTG**, TRD, TRS, TXP
 🔪 30169: **TRS**, TRD, TXP

30169

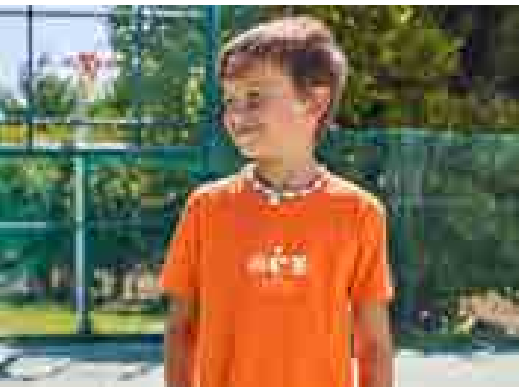

THC Ankara Kids

30170



106

100% cotton jersey Kids' t-shirt (unisex) (190 g/m²) with carded cotton yarn. Features a 1x1 rib collar with jersey reinforcement ribbon. Piece cut and sewn with a double seam on the sleeves and hemline.

📏 Sizes: 2, 4, 6, 8, 10, 12

🔪 30170: **DTG**, TRD, TRS, TXP
 🔪 30171: **TRS**, TRD, TXP

30171



THC Bucharest Kids

30312



106

Long-sleeved T-shirt (150 g/m²), with enzymatic treatment, for children in jersey fabric (100% cotton using sustainable farming practices). 1x1 rib collar with jersey reinforcement band. Tubular T-shirt with regular cut and double stitching on the sleeves and bottom of the article.

📏 Sizes: 2, 4, 6, 8, 10, 12

🔪 30312: **TXP**, TRD, TRS
 🔪 30311: **TXP**, TRD, TRS

30311



THC Move Kids

30276



106

Children's technical T-shirt (150 g/m²) in 100% polyester pique mesh. Regular cut t-shirt with breathable fabric and raglan sleeves. Double stitching on sleeves and bottom.

📏 Sizes: 4, 6, 8, 10, 12

🔪 30276: **TRS**, TRD
 🔪 30275: **TRS**, TRD

30275



30288

106

THC Delta Kids



Children's sweatshirt (300 g/m²) in cotton (50%) and recycled polyester (50%). Carded interior and 1x1 rib on collar, cuffs and hem.

📏 Sizes: 4, 6, 8, 10, 12

🔪 30288: **TXP**, EDB, ETD, TRD, TRS
🔪 30287: **TXP**, EDB, ETD, TRD, TRS



30287

103 105 114 128 134 149 183

30206

106

THC Phoenix Kids



Kids' hooded sweatshirt (unisex) in 50% cotton and 50% polyester (320 g/m²) with carded interior. Jersey lined hood, complying with the European Union safety standards. Sweatshirt with marsupial pocket and 1x1 Rib cuffs and waistband.

📏 Sizes: 2, 4, 6, 8, 10, 12

🔪 30206: **TRS**, EDB, ETD, TRD, TXP
🔪 30174: **TRS**, EDB, ETD, TRD, TXP



30174

102 103 105 114 134 154

183 158 164 168 169

30295

106

THC Amsterdam Kids



Enzyme-treated children's jacket in America terry (50% cotton using sustainable farming practices) and 50% recycled polyester (320 g/m²). Hood without drawstrings and lined in jersey in the same colour as the jacket, complying with European Union safety standards. Contains 1x1 rib cuffs and bottom, 2 side pockets, zipper with slider, puller and carded interior.

📏 Sizes: 4, 6, 8, 10, 12

🔪 30295: **TRS**, EDB, ETD, TRD, TXP
🔪 30294: **TRS**, EDB, ETD, TRD, TXP



30294

103 105 114 134 183

30302

103 105 113 114 134 159

THC Zagreb Kids



Children's jacket in 96% recycled polyester softshell and 4% elastane (280 g/m²), with two laces and water-resistant lining. Fleece-lined jacket (100% recycled polyester) with 2 front pockets and a diagonal chest pocket, both zippered. Removable and adjustable hood with drawstring and adhesive zipper strap to fit the collar. Front opening with YKK® zipper - a brand that uses modern equipment and high quality control. Adjustable cuffs with adhesive closure strap. Rounded lower back.

📏 Sizes: 4, 6, 8, 10, 12

🔪 **TRS**, EDB, ETD, TRD



Connect'in

MADE IN EUROPE

PAPER'IN

 .320

Our customisable bags service is the best way to get your brand noticed anywhere.

GRAPHIC'IN

 .321

Need to communicate your brand and don't know how? Discover the wide range of communication tools we offer.

BUTTON P'IN

 .322

The pins are the essential complement to highlight your brand, they can have a classic and discreet format or more be daring and original. You choose.

DOM'ING

 .323

Bring more life to your brand using the doming technique. Keyrings and pins are examples of pieces that can gain a little extra special shine.

LANYARD'IN

 .324

Because lanyards don't all have to be the same, with our Lanyards range you'll find more colours, patterns, lengths and accessories that fit your brand.



Direct import from Asia

connecting
USB you

 .330

A pen drive remains an essential tool for our daily lives, why not make it more original and fun?

Flexibility to go further

Elevate your brand and create products in your image in simple and small steps.

With Connect'in services, a world of new possibilities and choices opens up:



We have available more models and materials so that the final result is exactly as you like



We have more colours and accessories, because they make a difference in any product



Unusual formats so you can have an original offer



With short production lead times and fast deliveries

PAPER'IN

With our 100% customisable bags, you can select the model, materials and customisation you want. The result will be unique and original.

1

Material

- Matt couché 170 g/m²
- Extra options
- Shiny plasticization
- Cardboard base

2

Customisation

- CMYK print
- UV varnish

3

Rope handles

- Extra options*:
- Standard cords
- Polyester handles
- *other colours on request

Models

Small

Bag.

- 72886: 248 x 198 x 88 mm
- 72896: 180 x 230 x 80 mm
- Rope handle - 300 x 6 mm



72886 ○



72887 ○



72888 ○

Medium

Bag.

- 72887: 250 x 250 x 80 mm
- 72897: 230 x 320 x 100 mm
- Rope handle - 300 x 6 mm



72896 ○



72897 ○



72898 ○

Large

Bag.

- 72888: 415 x 320 x 140 mm
- 72898: 320 x 420 x 120 mm
- Rope handle - 300 x 6 mm



72899 ○



DELIVERY TIME:
FROM 10 WORKING DAYS.



MINIMUM ORDER QUANTITY:
500 UNITS.

PRICES AND CUSTOMISATION POSSIBILITIES ON REQUEST.

GRAPHIC'IN

The communication pieces and signage for your brand can be printed using our online simulator. A fast, intuitive and simple solution just a click away.

Roll-ups and L-banners

Material

✚ Semi-gloss canvas 340 gsm

Print type

✚ Digital

 **DELIVERY TIME:**
FROM 4 WORKING DAYS.

 **MINIMUM ORDER QUANTITY:**
NO MINIMUM ORDER QUANTITY



L-banner

Standard
☐ 800 x 2000 mm

Roll-ups

Roll-ups
☐ 850 x 2000 mm

Advertising flags

Material

✚ Windproof, resistant and durable fabric

Dimensions

Teardrop

- ☐ 790 x 1740 mm
- ☐ 1040 x 2350 mm
- ☐ 1290 x 2980 mm

Sail

- ☐ 580 x 2080 mm
- ☐ 681 x 2680 mm
- ☐ 860 x 3480 mm

Blade

- ☐ 630 x 1740 mm
- ☐ 681 x 2680 mm
- ☐ 870 x 3480 mm

Extras



Teardrop

Sail

Blade

 **DELIVERY TIME:**
FROM 5 WORKING DAYS.

 **MINIMUM ORDER QUANTITY:**
NO MINIMUM ORDER QUANTITY

BUTTON P'IN

Communicate your brand in an original way with our fully customisable pins, from the classic round to the bold rectangular. Print your design in full colour.



70005

Showcase available online

Accessories



+ Pin



+ Bottle opener



+ Magnet



+ Magnetic lock



+ Double magnetic lock

Several models and accessories to give your brand the image it deserves

Models

Rectangular



□ 79 x 53 mm / 80 x 53 mm



□ 53 x 78 mm

Accessories



+ Pin



+ Magnet

Round



□ Ø25 mm

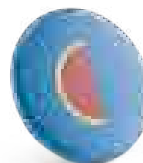

□ Ø38 mm



□ Ø50 mm

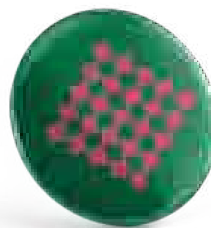

□ Ø57 mm



□ Ø59 mm

 **DELIVERY TIME:**
FROM 4 WORKING DAYS.

 **MINIMUM ORDER QUANTITY:**
100 UNITS.

PRICES AND CUSTOMISATION POSSIBILITIES ON REQUEST.

DOM'ING

Doming technique allows you to add volume and shine to your brand. Choose formats and accessories for exceptional and long-lasting results.



70005

Showcase available online

 **DELIVERY TIME:**
FROM 6 WORKING DAYS.

 **MINIMUM ORDER QUANTITY:**
250 UNITS.

Pins with support



- Round
 - Ø18 mm



- Rectangular
 - 19 x 15 mm
 - 20 x 18 mm

● Support colours



Flexible pins



- Round
 - Ø15 mm
 - Ø20 mm
 - Ø25 mm
 - Ø30 mm

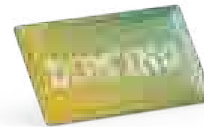

- Rectangular
 - 25 x 15 mm
 - 35 x 12 mm
 - 35 x 20 mm

● Support colours



- ◆ Special formats
 - De 3 a 7 cm²



- Squares
 - 15 x 15 mm
 - 20 x 20 mm
 - 25 x 25 mm

Keyring

Special formats

Dimensions

- De 9 a 42 cm²

Accessories

Ring
Chain

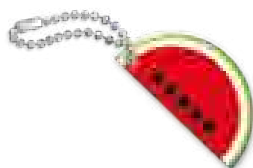

 **DELIVERY TIME:**
FROM 6 WORKING DAYS.

 **MINIMUM ORDER QUANTITY:**
100 UNITS.

LANYARD'IN

Choose from over 30 lanyard designs, different materials, accessories, colours and customise with your logo to create the perfect model for your brand.

● Colours/material

Cork

Accessories

Elastic

Available in all Pantone® colours

Locks

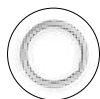

Ring



Carabiners



Hook



Combinations

Labels



Rubber



Polyester



Polyester jacquard



Cotton

Extras



Safety lock



Metal Clamp



Support cord



3D Accessory



Floating Cork

 **DELIVERY TIME:**
FROM 5 WORKING DAYS.

 **MINIMUM ORDER QUANTITY:**
NO MINIMUM ORDER QUANTITY

PRICES AND CUSTOMISATION POSSIBILITIES ON REQUEST.

Cork

A more sustainable and also customisable and with different accessories

Cork Long

Long: Ø3/Ø5 x 470 mm

Cork Short

Short: Ø3/Ø5 x 150 mm



Leather premiumchoice

Customisable through the stamping technique, the Lanyards in leather give a more elegant and sober touch

Material



Colours



Brown leather



Black leather



Blue leather



Red leather

Accessories

Locks



Ring



Carabiners



Hook



Combinations



Leather Long

Long: 10 x 470 mm

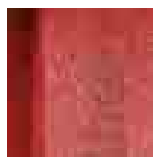

Leather Short

Short: 10 x 150 mm

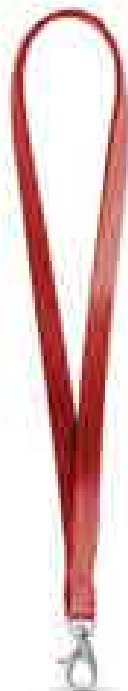

DELIVERY TIME:
FROM 7 WORKING DAYS.



MINIMUM ORDER QUANTITY:
NO MINIMUM ORDER QUANTITY

PRICES AND CUSTOMISATION POSSIBILITIES ON REQUEST.

Tube Jacquard

The Jacquard collection allows you to put your logo all over the ribbon

● Colours

96 Pantone® colours

Accessories

Tube Jacquard Tube Original Nautic

Elastic

Available in all Pantone® colours

Locks

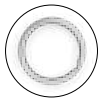

Ring



Carabiners



Hook



Combinations

Labels



Rubber



Polyester



Polyester jacquard



Cotton

Extras



Safety lock



Metal Clamp



Support cord



3D Accessory



Floating Cork



Floating



Cord lock



Labels in sublimation, rubber and doming

Jacquard Long

Long: Ø7 x 470 mm

Jacquard Short

Short: Ø7 x 150 mm



 **DELIVERY TIME:**
STANDARD COLOURS: FROM 5 WORKING DAYS.
SPECIAL COLOURS: FROM 9 WORKING DAYS.

 **MINIMUM ORDER QUANTITY:**
STANDARD COLOURS: NO MINIMUM ORDER QUANTITY.
SPECIAL COLOURS: 250 UNITS.

PRICES AND CUSTOMISATION POSSIBILITIES ON REQUEST.

Tube Original

For those who prefer the classic look

● Colours

40 colours standard | 96 Pantone® colours



Tube Long

Long: Ø7 x 470 mm



Tube Short

Short: Ø7 x 150 mm



Nautic

The collection that recalls beach days with its nautical fabric

● Colours

96 Pantone® colours



Nautic Long

Long: Ø7 x 470 mm



Nautic Short

Short: Ø7 x 150 mm



LANYARD 'IN

Sublimation

Ready for sublimation, these Lanyards, have the possibility to print on both sides of the ribbon



Slim

15 x 470 mm

Printing 1 side
Printing 2 sides



Standard

20 x 470 mm

Printing 1 side
Printing 2 sides



Duo Standard

20 x 470 mm

Printing 1 side
Printing 2 sides



Duo Slim

15 x 470 mm

Printing 1 side
Printing 2 sides

Material

Polyester

RPET

Polyester

RPET

Polyester

RPET

Polyester

RPET

Accessories

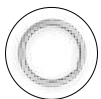

Ring



Carabiners



Hook



Combinations

Extras



Safety lock



Removable buckle



Support cord



PVC pouch



Eyeglass holder

Complete the Lanyards Duo Standard and Duo Slim with the Organic Cotton and Neoprene Cup Holders

Organic Cotton Cup Holder



Colours



Dimensions

□ 40 mm

Material



Organic Cotton



Kane
94324
📦 .186

Neoprene Cup Holder



Colours



Dimensions

□ 59 mm

Material



Neoprene



Kane
94324
📦 .186

Sublimation Wristband

□ 15 x 160 mm

Printing 1 side

Printing 2 sides

Material



Polyester



RPET

Extras



With security lock

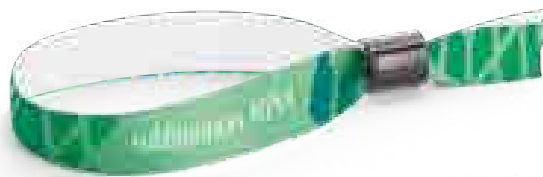

Extra accessory



DELIVERY TIME:
FROM 5 WORKING DAYS.



MINIMUM ORDER QUANTITY:
NO MINIMUM ORDER QUANTITY

connecting USB you

Interface 2.0 and 3.0 (on marked models)

DELIVERY TIME:
FROM 16 WORKING DAYS.

RoHS Certification RoHS

MINIMUM ORDER QUANTITY:
100 UNITS.



70070
Showcase available online



77702 / 77681

USB flash drive. Maple wood.
77681: interface 2.0. Capacity up to 32GB.
77002: interface 3.0. Capacity up to 128GB.
└ 60 x 19 x 10 mm

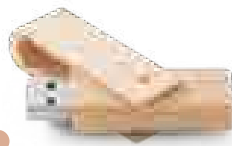

77701 / 77508

USB flash drive. Maple wood.
77701: interface 2.0. Capacity up to 32GB.
77508: interface 3.0. Capacity up to 128GB.
└ 59 x 19 x 12 mm

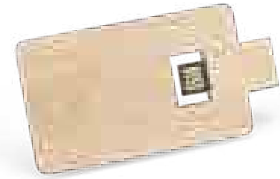

77509

UDP flash drive card. Maple wood.
└ 90 x 53 x 5 mm



77710 / 77712

USB flash drive. Bamboo wood.
77710: interface 2.0. Capacity up to 32GB.
77712: interface 3.0. Capacity up to 128GB.
└ 60 x 19 x 10 mm



77714 / 77716

USB flash drive. Bamboo wood.
77714: interface 2.0. Capacity up to 32GB.
77716: interface 3.0. Capacity up to 128GB.
└ 60 x 19 x 10 mm



77708

UDP flash drive card. Bamboo wood.
└ 90 x 53 x 5 mm



77711 / 77713

USB flash drive. Walnut wood.
77711: interface 2.0. Capacity up to 32GB.
77713: interface 3.0. Capacity up to 128GB.
└ 60 x 19 x 10 mm



77715 / 77717

USB flash drive. Walnut wood.
77715: interface 2.0. Capacity up to 32GB.
77717: interface 3.0. Capacity up to 128GB.
└ 60 x 19 x 10 mm

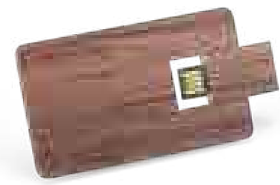

77709

UDP flash drive card. Walnut wood.
└ 90 x 53 x 5 mm



77603

Box for USB flash drive.
Bamboo. Sold only with USB flash drive.
└ 80 x 51 x 25 mm



77604

Box for USB flash drive.
Recycled cardboard. Sold only with USB flash drive.
└ 91 x 40 x 23 mm



77689

USB flash drive. Cork.
└ 22 x 49 mm



77696

USB flash drive. Recycled plastic.
Any Pantone® colour starting at 1,000 pcs.
└ 53 x 19 x 6 mm

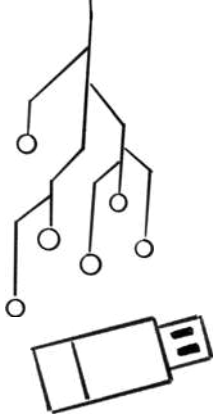

77503
Mini UDP flash drive. Metal. With carabiner clip.
± 51 x 12 x 5 mm



77562
Mini UDP flash drive. Aluminium.
± 12 x 37 x 5 mm



77706
USB flash drive with silicone grip. Metal body.
± 33 x 12 mm



77559
USB flash drive. Any Pantone® colour starting at 1.000 pcs.
± 57 x 17 x 7 mm



77502
USB flash drive. Stainless steel and ABS. With carabiner clip. Any Pantone® colour starting at 1.000 pcs.
± 61 x 18 x 9 mm



77505
USB flash drive. Imitation leather. With carabiner clip. Any Pantone® colour starting at 1.000 pcs.
± 100 x 26 x 11 mm



77523
USB flash drive. Imitation leather. Any Pantone® colour starting at 500 pcs.
± 80 x 21 x 16 mm



77688
USB flash drive. Any Pantone® colour starting at 100 pcs.
± 55 x 17 x 10 mm



77561
USB flash drive. Clip: chrome. Body: Any Pantone® colour starting at 100 pcs.
± 58 x 18 x 10 mm

+
Capacity



77516
USB flash drive. Interface 3.0. Clip: chrome. Body: Any Pantone® colour starting at 100 pcs.
± 58 x 18 x 10 mm



DELIVERY TIME:
FROM 12 WORKING DAYS.



77630
USB flash drive. Clip: chrome. Body: Any Pantone® colour starting at 100 pcs.
± 58 x 18 x 10 mm



77560
USB flash drive. Clip: any Pantone® colour starting at 1.000 pcs. Body: Any Pantone® colour starting at 100 pcs.
± 58 x 18 x 10 mm



77432
Memória USB. Metal.
± 42 x 22 x 9 mm



77704
USB flash drive. Interface 3.0. Clip: chrome. Body: Any Pantone® colour starting at 100 pcs.
± 58 x 18 x 10 mm



77591

Mini UDP flash drive. Aluminium.
± 12 x 37 x 5 mm



77506

Mini UDP flash drive. Aluminium.
± 12 x 37 x 5 mm



77673

Mini UDP flash drive. Aluminium.
± 12 x 37 x 5 mm



77504

Mini UDP flash drive.
± 39 x 15 x 7 mm



77692

UDP flash drive card.
± 86 x 54 x 2 mm



77695

UDP flash drive card.
± 86 x 54 x 3 mm

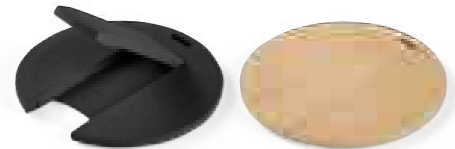

77705

UDP memory in wheat fiber and plastic.
± Ø44 mm



77602

Box for USB flash drive. ABS. With PE window. Sold only with USB flash drive.
± 89 x 89 x 20 mm



77610

Box for USB flash drive. Transparent PP, with magnet. Sold only with USB flash drive.
± 103 x 72 x 10 mm



77614

Box for USB flash drive. Transparent PP, with magnet. Sold only with USB flash drive.
± 95 x 46 x 21 mm



77601

Box for USB flash drive. PP. Sold only with USB flash drive.
± 68 x 25 x 15 mm



Extras



77618

Box for USB flash drive. Metal. Sold only with USB flash drive.
± 115 x 85 x 22 mm



77577

Keyring



77582

Keyring



77699

Lanyard
± 7 x 370 mm





77513

UDP ball pen flash drive.
Black ink ball pen and touch
tip.
£ ø14 x 136 mm



77500

UDP ball pen flash drive.
Black ink ball pen. Any
Pantone® colour starting at
2,000 pcs.
£ ø14 x 135 mm



77515

USB ball pen flash drive. Black
ink ball pen. Any Pantone® colour
starting at 500 pcs.
£ 134 x 17 x 15 mm



77641

USB flash drive. Any Pantone®
colour starting at 2,000 pcs.
£ 74 x 18 x 10 mm

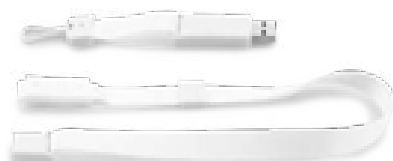

77423

USB flash drive with lanyard. Any
Pantone® colour starting at 500 pcs.
£ 16 x 500 x 8 mm



77664

USB flash drive bracelet. Any
Pantone® colour starting at 500 pcs.
£ 219 x 20 x 9 mm

Formats that remain in memory. Create the shape of your USB

77700

USB flash drive. PVC. Any
special model available
starting at 250 pcs.

















DELIVERY TIME:
FROM 23 WORKING DAYS.



Icon index

	Waterproof		Black, blue, red and green ink		Made in EU
	Automatic opening		Bamboo Fibre		Twist mechanism
	Recycled ABS		Wheatstraw Fibre		Our nature
	Stainless steel		Natural Straw Fibre		Kraft paper
	Recycled stainless steel		3 m measuring tape		Stone Paper
	Recycled cotton		5 m measuring tape		Recycled Paper
	Recycled Aluminium		Plain sheets		Handle with spring
	Suitable for cold drinks		Ivory plain pages		Laptop in inches
	Suitable for hot drinks		Kraft plain sheets		Tablet Inches
	Suitable for hot and cold drinks		Lined sheets		Touch tip
	Suitable for cold/hot drinks (hours)		Ivory lined pages		Registered product
	Food grade		Kraft lined sheets		Thermal protection
	Suitable for freezer		Dotted leaves		Sustainable forest product
	Suitable for washing machine		Supplied in a gift box		Recycled PU
	Microwave safe		Female		Elephant Poop
	BPA Free		Male		Tea Leaf Waste
	Capacity L		Fiber rib umbrella		rPET
	Capacity L		Magnet		Rotary screen printing
	Capacity L		Double insulation		A4 size
	Calcium Carbonate		Juco		A5 size
	Wireless Charger		Jute		A6 size
	Coffee Husks		Mechanical pencil 0.7		A7 size
	Cork		Laser		B6 size
	Reflective elements		LED		B7 size
	Blue ink		LED COB		Pocket size
	Black ink		TF reader		BT transmission
	Black, blue and red ink		Flax		Unisex



	Wireless Range		iOS and Android compatible		Water Resistance
	Wireless Earphones		Cable length		Screen Resolution
	Battery Autonomy		AUX input		Input type
	In use and standby autonomy		Response frequency		Type-C connector
	Volume at capacity		Charging power		BT Transmission
	Wireless Charging		Sound power		Volume at capacity

Colour Scheme

- ☺ 100 Assorted
- 101 Brown
- 102 Pink
- 103 Black
- 104 Blue
- 105 Red
- 106 White
- 107 Silver
- 108 Yellow
- 109 Green
- 110 Transparent
- 111 Light brown
- 112 Light pink
- 113 Grey
- 114 Royal blue
- 115 Burgundy
- 116 Pastel white
- 117 Golden
- 118 Dark yellow
- 119 Light green
- 121 Dark brown
- 122 Dark pink
- 123 Light grey
- 124 Light blue
- 127 Satin silver
- 128 Orange
- 129 Dark green
- 131 Beige
- 132 Purple
- 133 Dark grey
- 134 Navy blue
- 137 Satin gold
- 138 Dark orange
- 139 Lime green
- 141 Terracotta
- 142 Lilac
- 143 Black/Satin silver
- 144 Turquoise blue
- 146 Green jade
- 147 Gun metal
- 148 Lime yellow
- 149 Army green
- 150 Light natural
- 152 Pastel pink
- 153 Black/White
- 154 Acqua blue
- 157 Copper
- 158 Pastel yellow
- 159 Pastel green
- 160 Natural
- 163 Black/Heather light grey
- 164 Pastel blue
- 167 Champagne
- 168 Salmon
- 169 Turquoise green
- 170 Dark natural
- 173 Heather anthracite
- 174 Petrol blue
- 178 Coral orange
- 183 Heather light grey
- 184 Eclipse blue
- 188 Hexachrome yellow
- 189 Mint green
- 194 Heather blue
- 195 Heather red
- 196 Melange white
- 198 Hexachrome orange
- 208 Digital yellow

Colour Scheme

- 300 Black
- 301 White
- 302 Red
- 303 Blue
- 304 Light blue
- 305 Royal blue
- 307 Green
- 308 Light green
- 309 Dark green
- 310 Yellow
- 311 Orange
- 312 Pink
- 315 Burgundy
- 316 Purple
- 320 Brown
- 323 Beige
- 324 Grey
- 327 Hexachrome yellow
- 328 Hexachrome orange
- ☺ 330 Assorted
- 332 Light natural
- 333 Natural
- 334 Dark natural
- 340 Silver
- 341 Golden
- 342 Satin silver
- 344 Gun metal
- 345 Copper
- 346 Champagne
- 347 Metallic blue
- 348 Metallic red
- 350 Black/White
- 351 Black/Grey
- 352 Black/Royal blue
- 353 Black/Light blue
- 354 Black/Red
- 355 Black/Pink
- 356 Black/Orange
- 357 Black/Yellow
- 358 Black/Green
- 360 Hexachrome yellow/Hexachrome pink
- 361 Hexachrome yellow/Hexachrome orange
- 362 Hexachrome yellow/Royal blue
- 363 Hexachrome yellow/Black
- 364 Hexachrome orange/Royal blue
- 365 Hexachrome pink/Light blue
- 366 Hexachrome pink/Royal blue
- 367 Hexachrome green/Hexachrome pink
- 368 Hexachrome green/Orange
- 369 Hexachrome green/Black
- 370 Yellow/Light blue
- 371 Yellow/Green
- 372 Purple/Light blue
- 373 Brown/Beige



Stay updated



@hideagifts

hideagifts.com

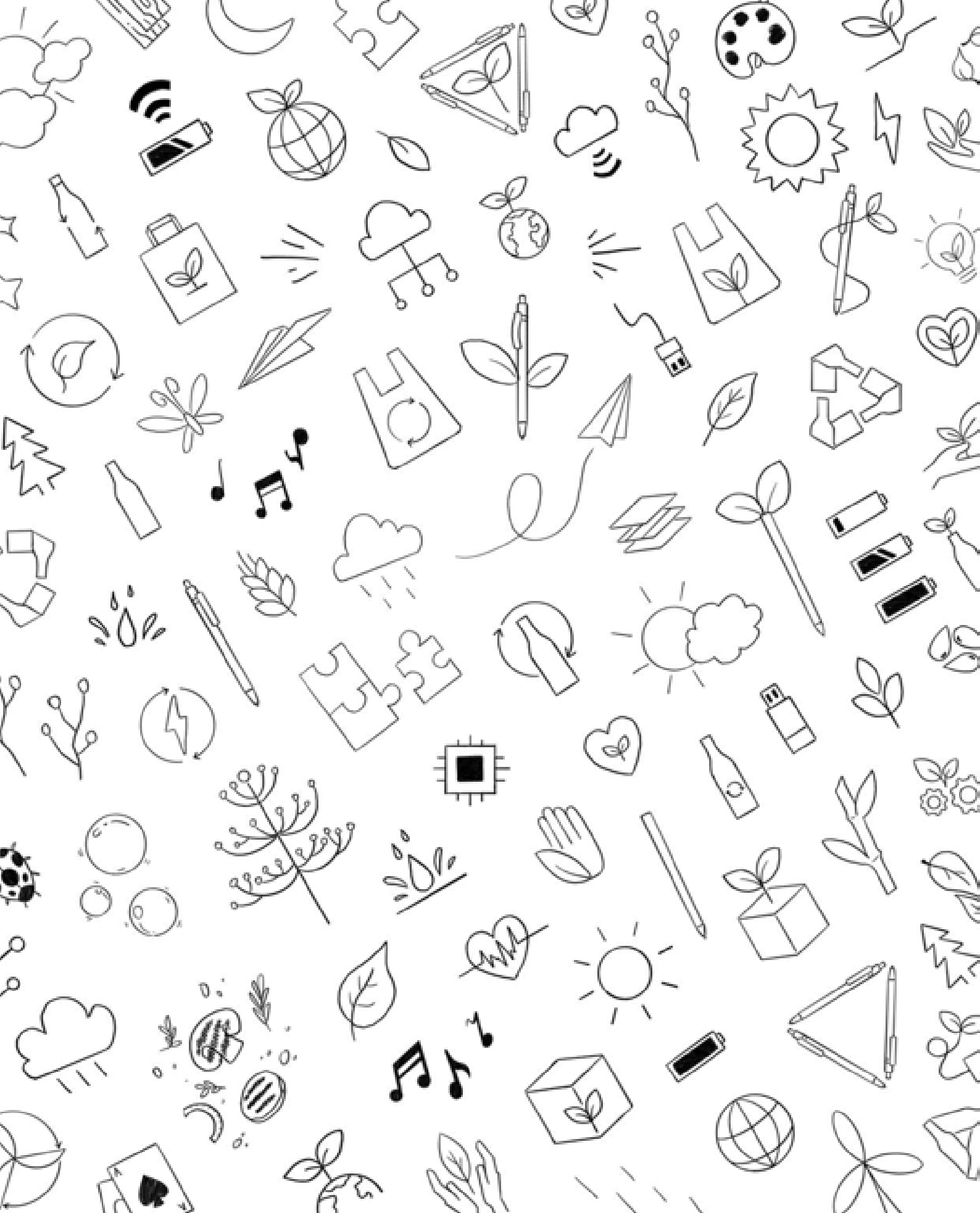

2024

